



Storage systems



Contents

Storage Systems

PALLET STORAGE SYSTEMS

06 Pallet Racking

The universal system for direct access to each pallet.

08 Mobile Racking (Movirack)

Large-scale storage on mobile shelving units.

10 Drive-In/Drive-Through Racking System

Storage by accumulation with optimal use of available space.

12 Pallet Shuttle Racking System

Optimised accumulative storage system.

14 Pallet Flow Racking

Perfect for storing high-turnover perishable goods and high-consumption products.

16 Push-Back Pallet Racking

Ideal for accommodating medium-turnover goods, with two or more pallets per SKU.

18 Rack-Supported Warehouse

Great works of engineering in which the racking forms the structure of the building.

20 Automated Warehouses for Pallets

Automation for maximum efficiency.

22 Stacker Cranes

Machines created for the automated storage of loads.

24 Automated Pallet Shuttle

The most efficient solution for mass product throughput.

26 3D Automated Pallet Shuttle

High-density automated storage and maximum productivity.

28 Automatic Trilateral Stacker Crane

The perfect solution for automating conventional pallet racking.

30 Pallet Conveyor Systems

Set of elements designed to transport, accumulate and distribute pallets.

BOX STORAGE SYSTEMS

32 M7 Heavy Duty Storage Racks

Shelving with multiple possibilities for picking bulky or heavy loads.

34 Pick Modules

Maximising the use of a facility's height.

36 M3 Light Duty Racks

Manual storage and archiving system for light and medium loads.

38 Live Storage for Picking

Perfect turnover within arm's reach.

40 Automated Warehouses for Boxes

Optimal for automatic storage with goods-to-person picking operations.

42 Stacker Cranes for Boxes

Using robotics to reach high productivity levels and automate product management.

44 Shuttle System

Automated shuttle storage solution for boxes and small products.

46 High-Performance Pick Station

Technology that combines ergonomics, efficiency and productivity.

48 Picking Robot

Robotic system that leverages artificial intelligence to automate order picking.

50 Box Conveyor Systems

Transport devices for covering any distance within a facility.

52 Autonomous Mobile Robots (AMRs)

Autonomous goods transport solution that adapts routes in real time.

OTHER SYSTEMS

54 Cantilever Racking

Simple system designed for storing long loads.

56 Mezzanine Floors

Industrial raised flooring used to multiply the original surface area.

58 Wire Mesh Partitions & Cages

Useful for enclosing work areas.

60 Special Projects

Our customised storage service.

MANAGEMENT SOFTWARE

62 Easy WMS Warehouse Management System

Control, coordination and supervision of all the processes at work in a facility.

64 Easy DOM Distributed Order Management

Productivity and cost-effectiveness in omnichannel order fulfilment.

SERVICES

66 Lifecycle Services

Wide range of after-sales solutions covering the warehouse lifecycle.

68 Warehouse Racking Inspections

Rack use, inspection and maintenance.

Quality Standards



ISO 9001

Mecalux holds ISO 9001 certification, ensuring quality management in the design, production, installation and after-sales service of its storage products. The ISO 9001 certificate has been awarded to the production plants in Spain, Mexico and Argentina for all Mecalux static, mobile and live storage metal racking, light-duty shelving, mezzanines, lockers and office partitioning.



ISO 14001

Mecalux is aware of environmental issues and the impact of the work carried out at its plants. Applying the Environmental Management System (EMS) to our activities guarantees that all organisational, production and technical work that could affect the environment is planned, managed and controlled in compliance with the ISO 14001 standard.



ISO 45001

Occupational health and safety is a crucial part of daily management for companies nowadays. To prevent accidents and ensure a safe working environment, Mecalux has obtained the internationally recognised ISO 45001 certification, which specifies the requirements for proper health and safety management in the workplace.

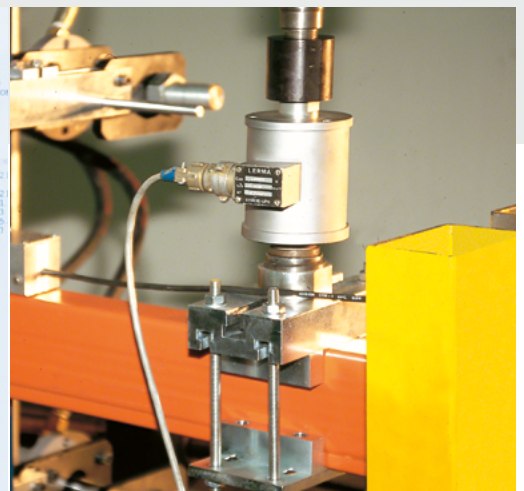
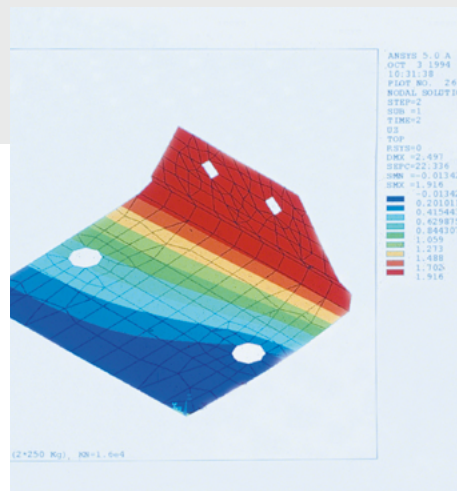

TÜV-GS

In October 2000, the world-renowned German company TÜV Product Service GmbH awarded Mecalux its quality certificate after auditing and testing the material handling instructions and the design, production and assembly processes of our products.

EN 15512 STANDARD

Aware of the need to apply the most advanced safety techniques to racking and shelving, Mecalux has been adapting its products and services to suit the European Federation of Materials Handling's recommendations for the new system of calculation, design and testing of metal shelving since 1995.

These recommendations form European standard EN 15512, which aligns with the existing EU directive on calculating metal structures for conventional racking. It also regulates the process and tolerances for the assembly and control of materials. The standard focuses on a global analysis of racking stability and strength, applying second-order calculation methods using finite elements.

Pallet Racking

- The universal system for **direct access** to each pallet.
- **Makes maximum** use of storage locations.
- Can be **adapted** to any pallet size or weight.



Conventional pallet racking is the best solution for warehouses that need to store a wide range of items on pallets.

The variety of profiles and accessories provides optimal adaptation to each load and height requirement.

The layout and height of the racking are determined by the characteristics of the forklifts, the pallets to be stored and the dimensions of the premises.

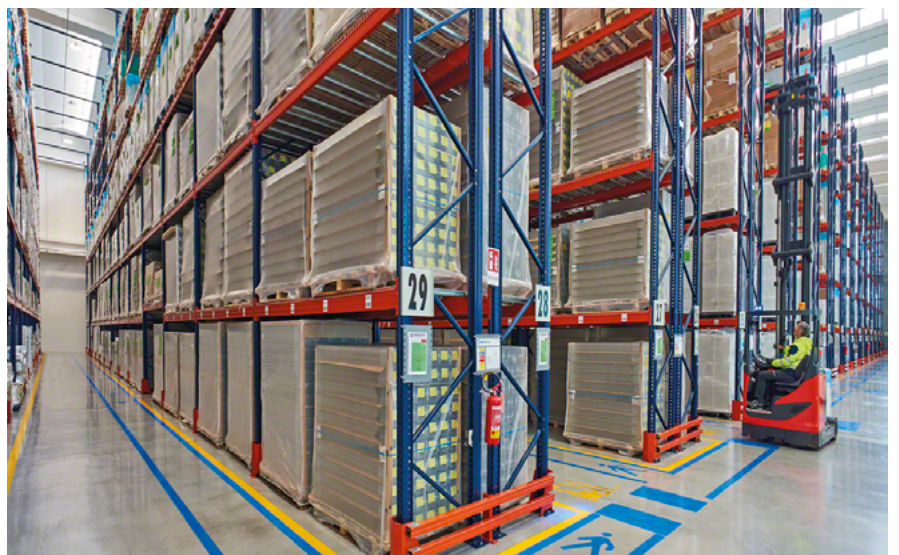

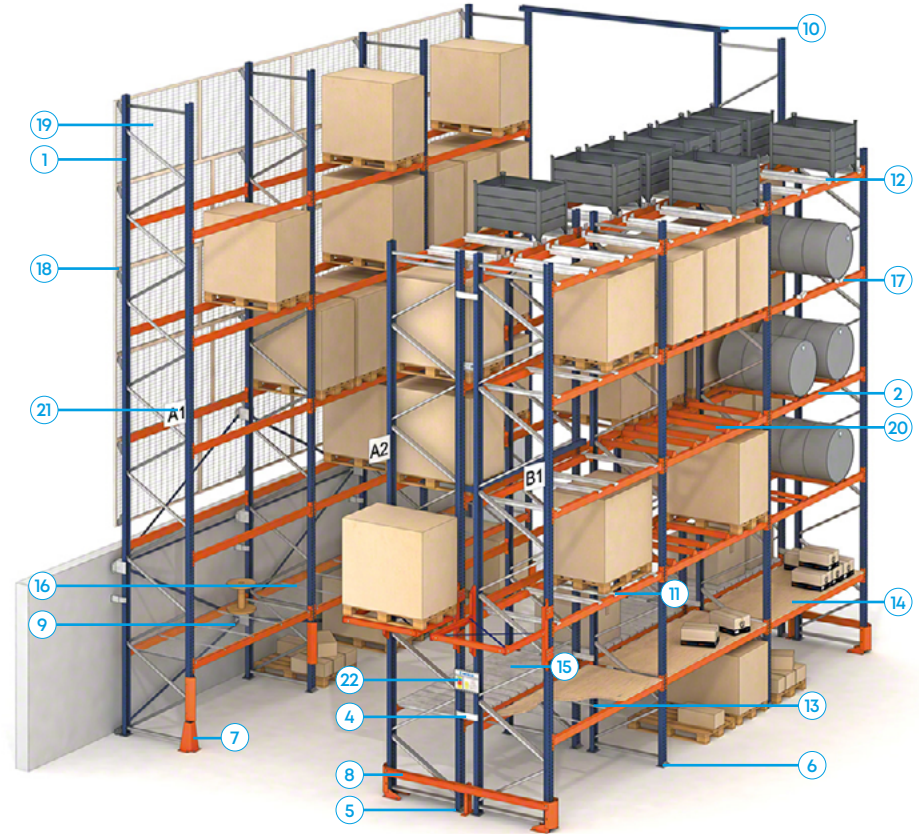
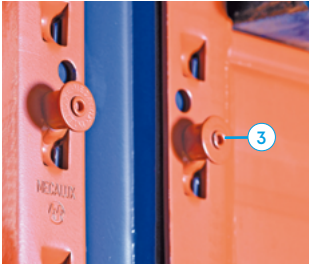

- | | |
|----------------------------------|----------------------------|
| 1. Frame | 17. Drum support |
| 2. Beam | 18. Back stop rails |
| 3. Safety locking mechanism | 19. Anti-fall mesh |
| 4. Row spacer | 20. Raised cross tie |
| 5. Anchor bolts | 21. Aisle sign |
| 6. Levelling shims | 22. Safe load warning sign |
| 7. Upright protector | |
| 8. Lateral protection barrier | |
| 9. Cross bracing set | |
| 10. Top portal tie | |
| 11. Pallet support bar | |
| 12. Container support bar | |
| 13. Chipboard shelving cross tie | |
| 14. Chipboard or melamine shelf | |
| 15. Galvanised picking shelf | |
| 16. Mesh shelf | |



Combined with picking

Conventional pallet racking can incorporate picking shelves for the manual selection of goods, as orders are often prepared in the access aisles.

Mobile Racking (Movirack)

- **Space optimisation** and **increased** warehouse storage capacity.
- **Direct access** to each pallet.
- Optimal system for both **refrigerated** and **frozen cold storage**.



The racking is mounted on mobile bases that move along rails, eliminating the need for multiple access aisles and boosting storage capacity.

Mobile pallet racking makes maximum use of available space and provides direct access to every pallet stored within the system.

The mobile bases have motors, sliders, electronics and several safety systems to guarantee safe, efficient operation.

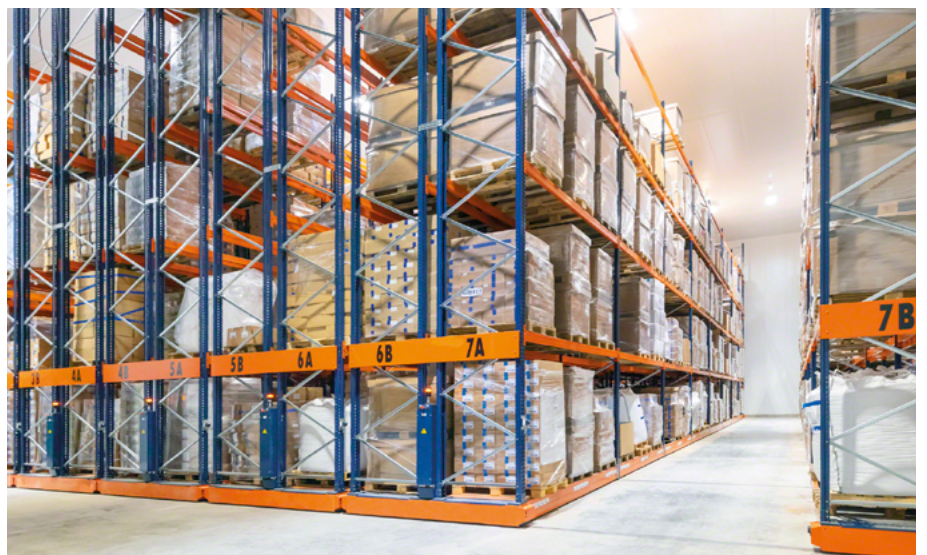

Racks

1. Frame
2. Beam
3. Anchorage and fasteners
4. Vertical bracing
5. Horizontal bracing
6. Base fasteners
7. Pick and deposit (P&D) station (optional)
8. Roller carriage/drive carriage
9. Guide carriage
10. End of carriage
11. Base beam
12. Bracing set
13. Motor
14. Cable channel
15. Drive shaft
16. Main power cabinet
17. Onboard power panel
18. Signal and power cables
19. Remote control antenna
20. Remote control
21. Exterior safety barrier
22. Interior safety barrier and proximity photocell
23. Reset button
24. Emergency stop button
25. Guide rail
26. Roller rail

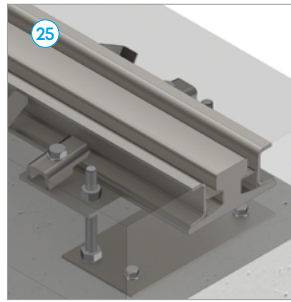

Guide rail

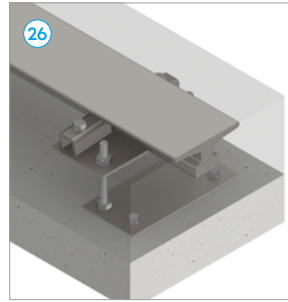

Roller rail

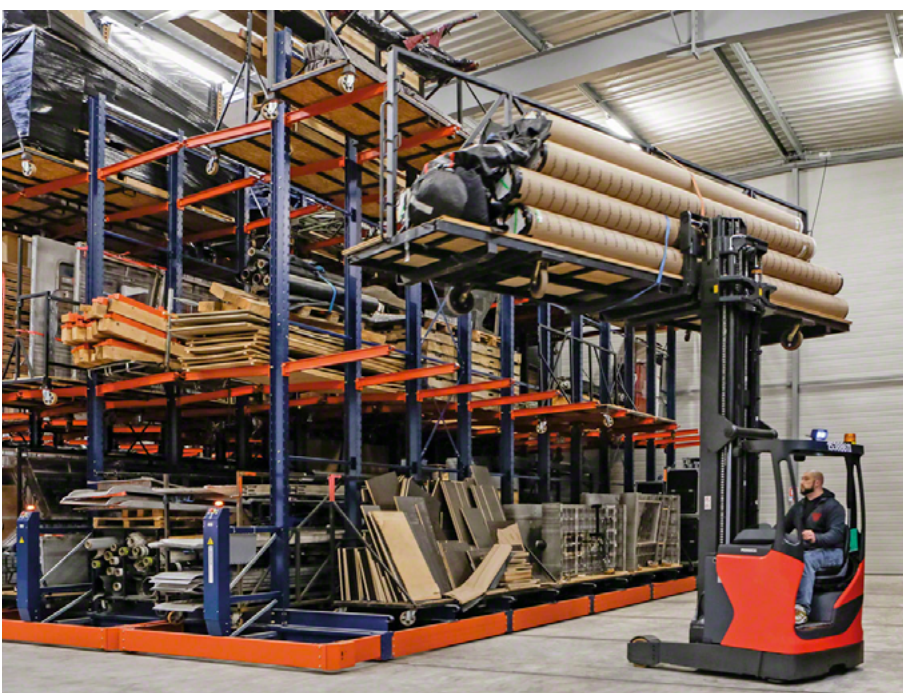
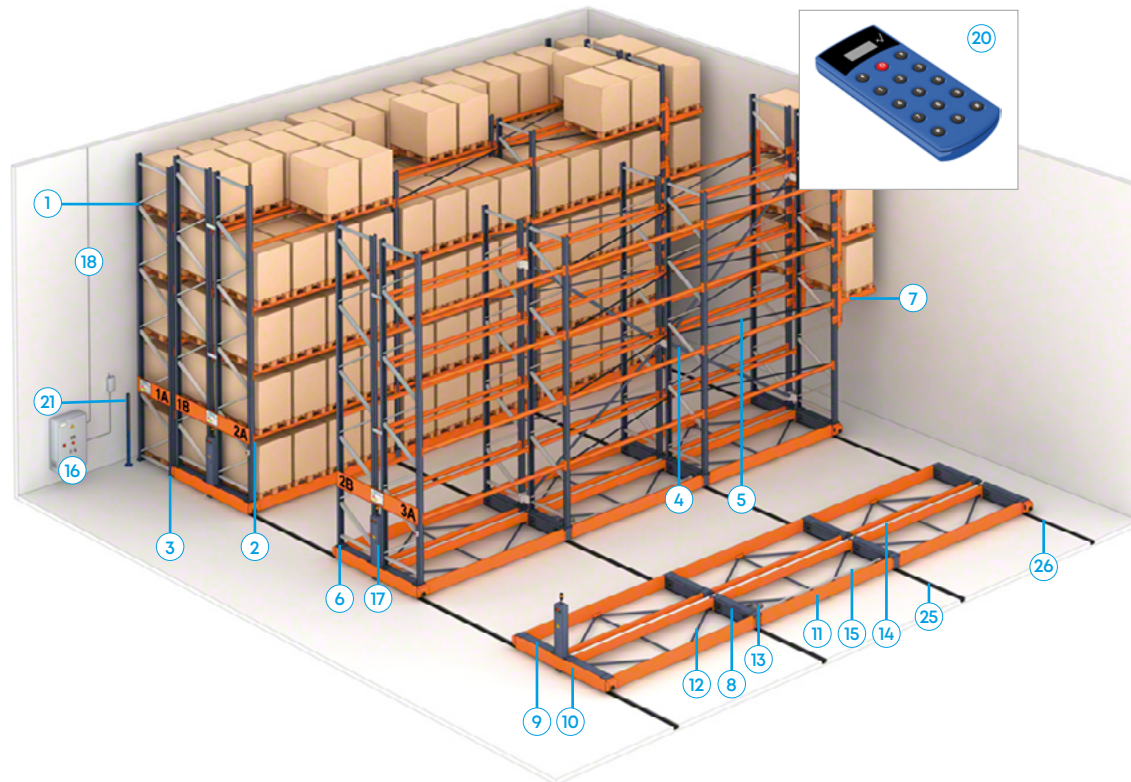
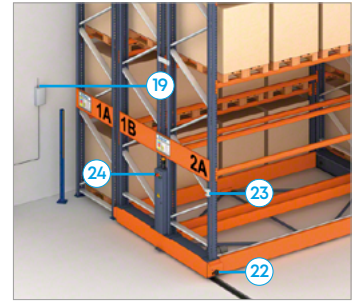

Combined with cantilever racking

Mobile pallet racking can incorporate cantilever racks to store longer products and increase warehouse storage capacity.

Drive-In/Drive-Through Racking System

- **Maximum utilisation of available space** (up to 85%).
- Ideal system for storing **homogeneous, low turnover products** with a large number of pallets per SKU.
- **Elimination of aisles** between racks.

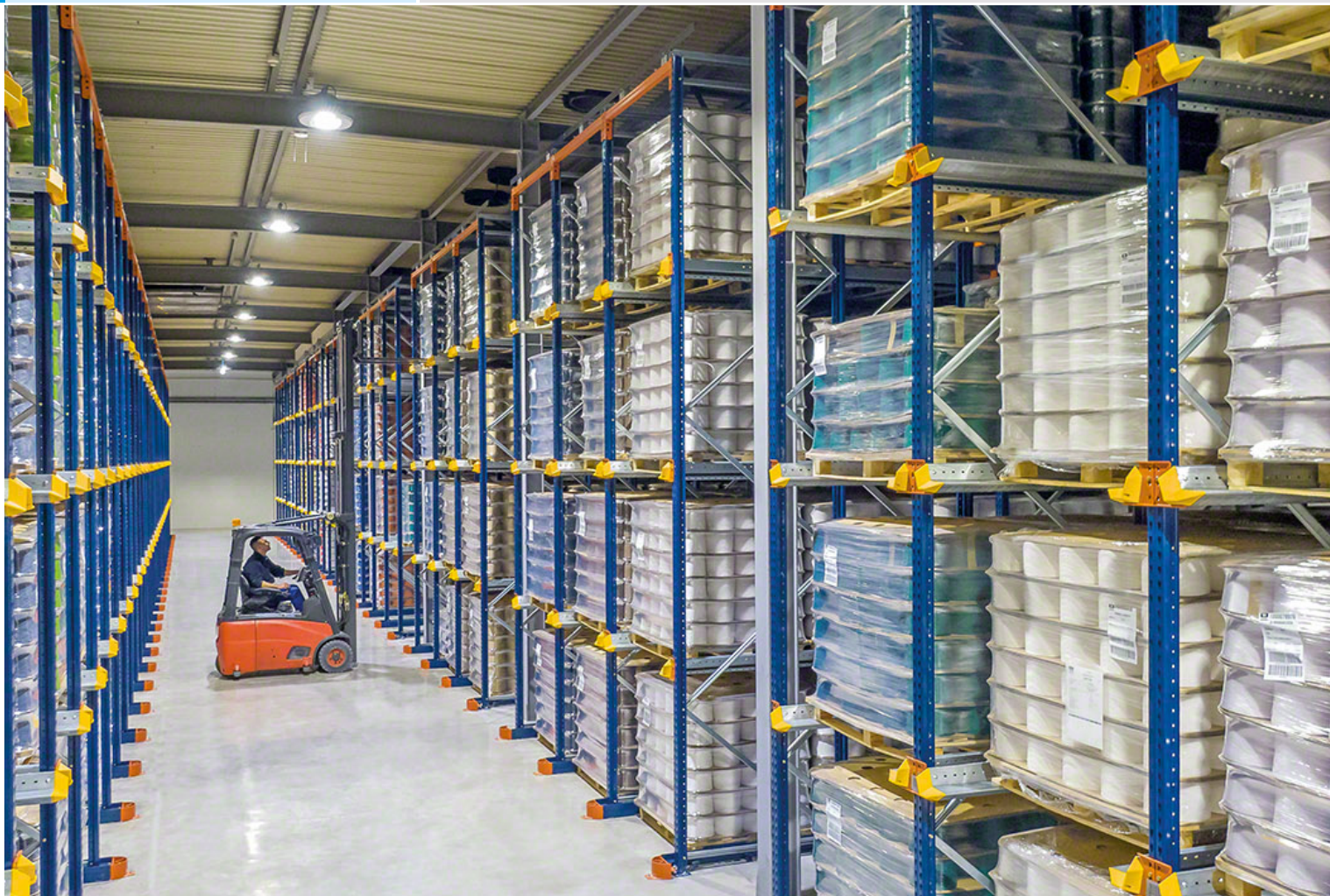

This storage concept consists of a set of racking units that form an internal lane with support rails for pallets. The forklift enters the lane with the load elevated above the support rail on which it will be placed.

Guide rails facilitate forklift manoeuvres, aiding movement and minimising the possibility of accidental damage.



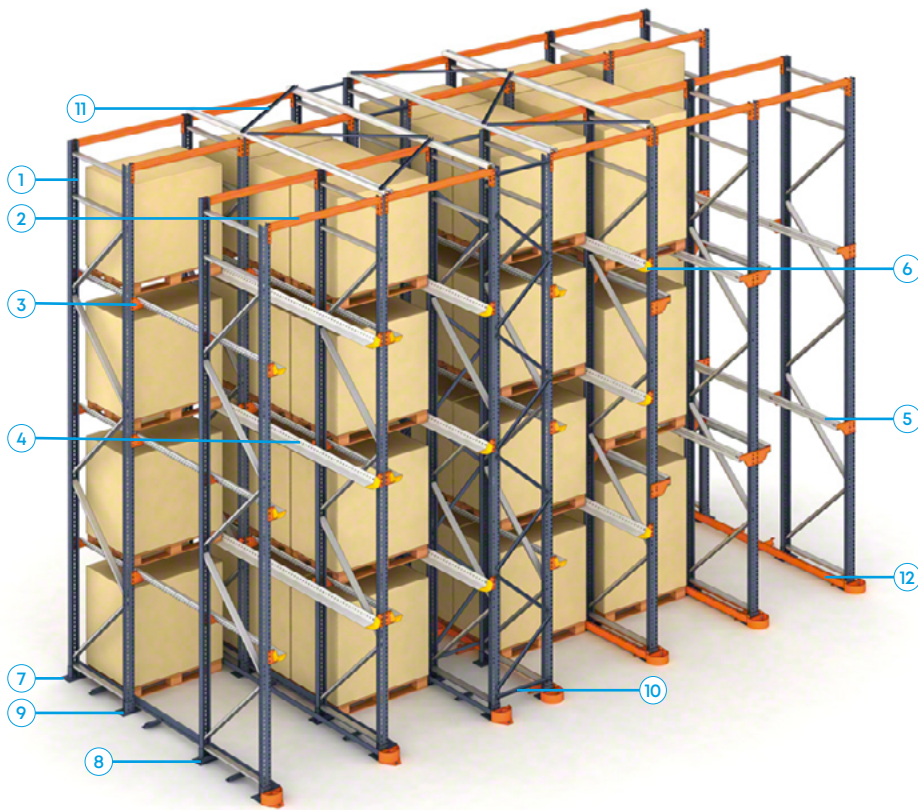

1. Frame
2. Drive-in beam
3. Rail bracket
4. GP rail
5. C-rail
6. Pallet centraliser
7. Upright footplate
8. Shim
9. Anchor bolts
10. Bracing set
11. Upper cross bracing
12. Guide rail and protector (optional)



Pallet centraliser

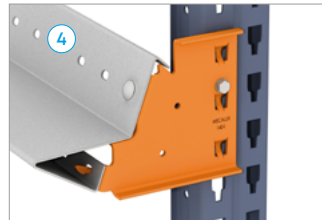

GP rail

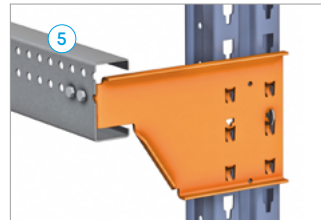

C-rail

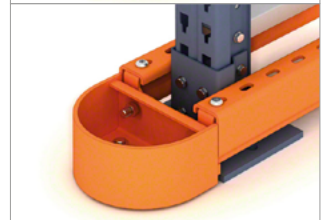
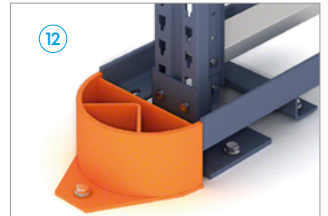

Guide rail and protector

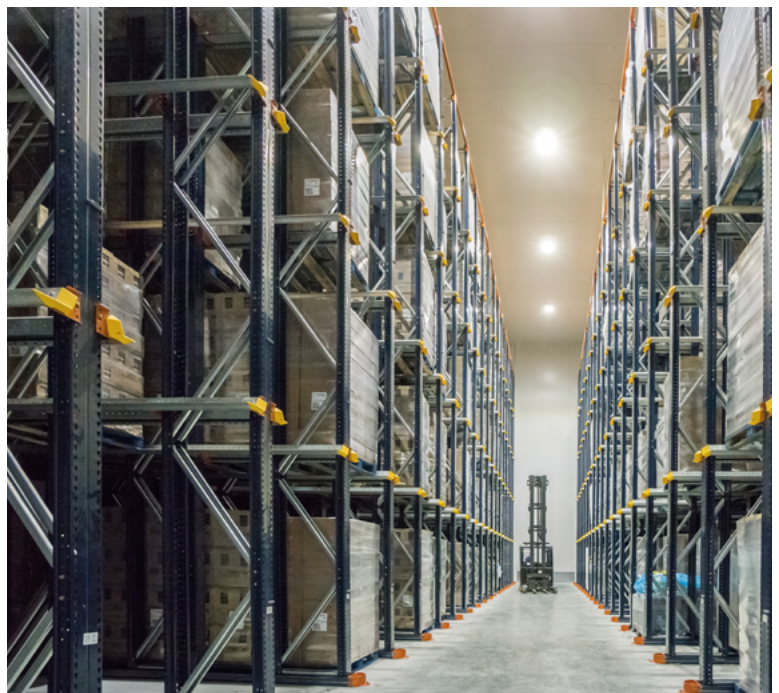

Pallet Shuttle Racking System

- **High-density**, large-capacity storage.
- **Reduced** loading and unloading **times**.
- **Larger number of stored products** (one SKU per channel).
- **Lower risk** of accidents.
- **Less damage** to racking units.
- Ideal for **cold storage** warehouses.



This high-density pallet storage system facilitates the independent loading and unloading of goods via an electric shuttle car, eliminating the need for forklifts to enter the racking.

The forklift places the load onto the rails at the channel entrance. The Pallet Shuttle then picks it up and moves it along the rails, depositing it in the assigned location.

The forklift operator manages all storage and retrieval movements using a radiofrequency remote control or a Wi-Fi device, which can control up to 18 channels.



Structural components

1. Upright
2. Beam
3. Rail
4. External rail support
5. Internal rail support
6. Rail end stops
7. Centraliser

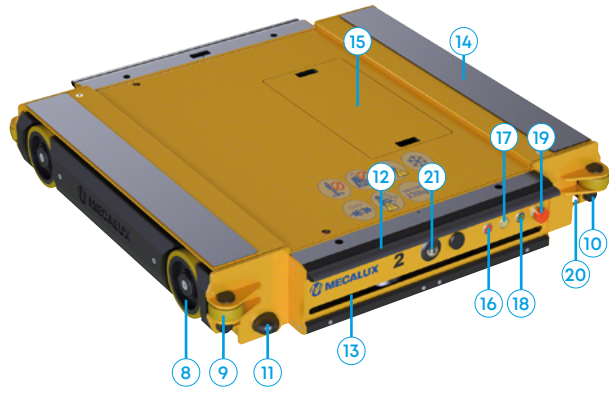
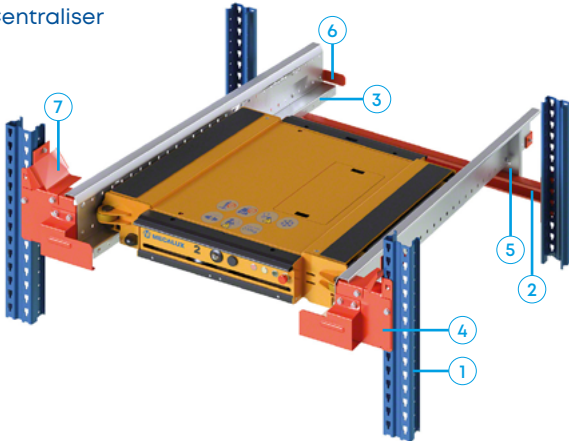

Shuttle components

- | | |
|--|--|
| <ol style="list-style-type: none"> 8. Wheel 9. Contrast wheel 10. Shuttle stop 11. Antenna 12. Safety bumper 13. Safety scanner (optional) 14. Lifting platform | <ol style="list-style-type: none"> 15. Battery compartment 16. Fault indicator 17. Battery status indicator 18. On/off switch 19. Emergency stop button 20. End-of-track sensor 21. Positioning camera (optional) |
|--|--|



STEP 1
A forklift places a Pallet Shuttle on the level where the goods will be stored.



STEP 2
The forklift loads the pallets one by one at the level's entrance, supporting them on the loading sections.



STEP 3
The shuttle raises one pallet slightly and then moves horizontally until reaching the first open location, where it sets the pallet down.



STEP 4
The shuttle returns to the lane entrance to repeat the procedure with the next pallet, continuing successively until the lane is full. Once the last location is filled, the shuttle is extracted, ready to work on another level.

To remove pallets, the procedure is the same but in reverse order.



Pallet Flow Racking

- Enables **flawless turnover** of stored products through the first in, first out (FIFO) system.
- **Optimal stock control**. Only one product type is stored in each channel.
- **Time saved** in pallet handling.
- **Maximum capacity**.
- **Interference eliminated** through separate aisles for loading and unloading.



Live storage racking features roller tracks on a slight incline, allowing pallets to slide smoothly in each lane.

The pallets are placed at the highest point of the rolling section and then move by the force of gravity at a controlled speed towards the other end, ready to be removed.



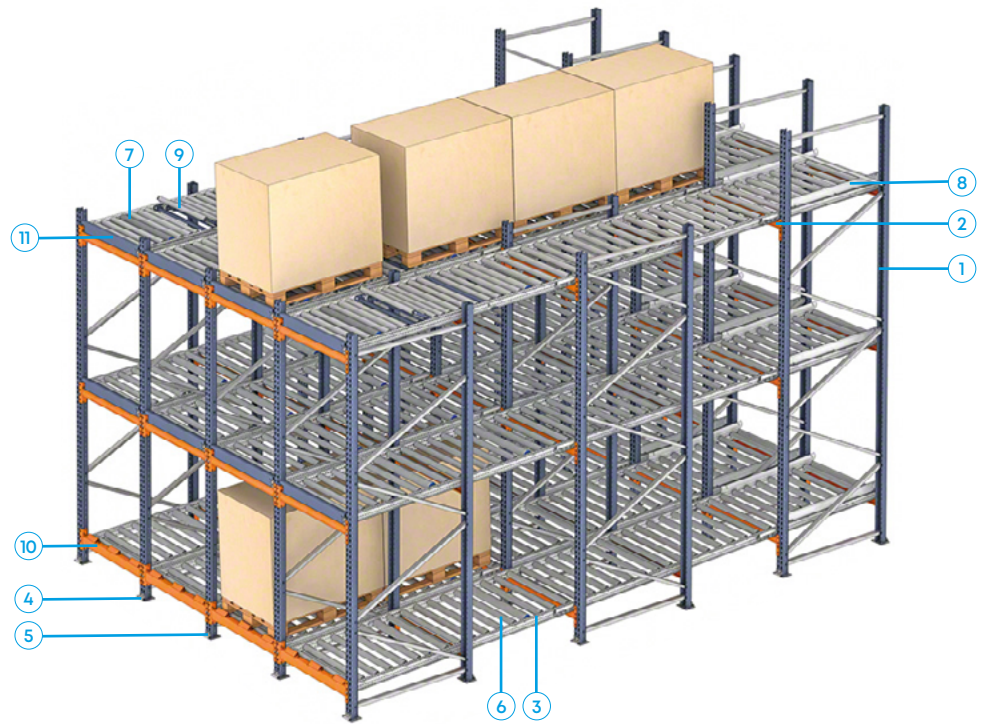

- 1. Frames
- 2. Live crossbeam
- 3. Profile
- 4. Levelling plates
- 5. Anchor bolts
- 6. Rollers
- 7. Brake roller
- 8. Centralising strips
- 9. Pallet retainers (optional)
- 10. Exit beam
- 11. End stop



Rollers



Brake roller



Centralising strips

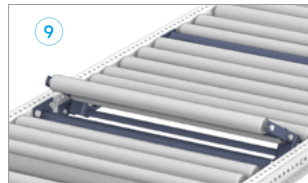

Pallet retainers

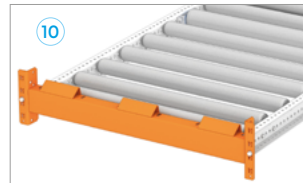

Exit beam

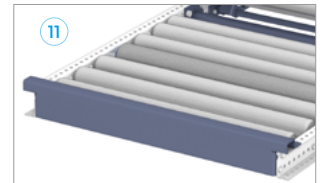

End stop

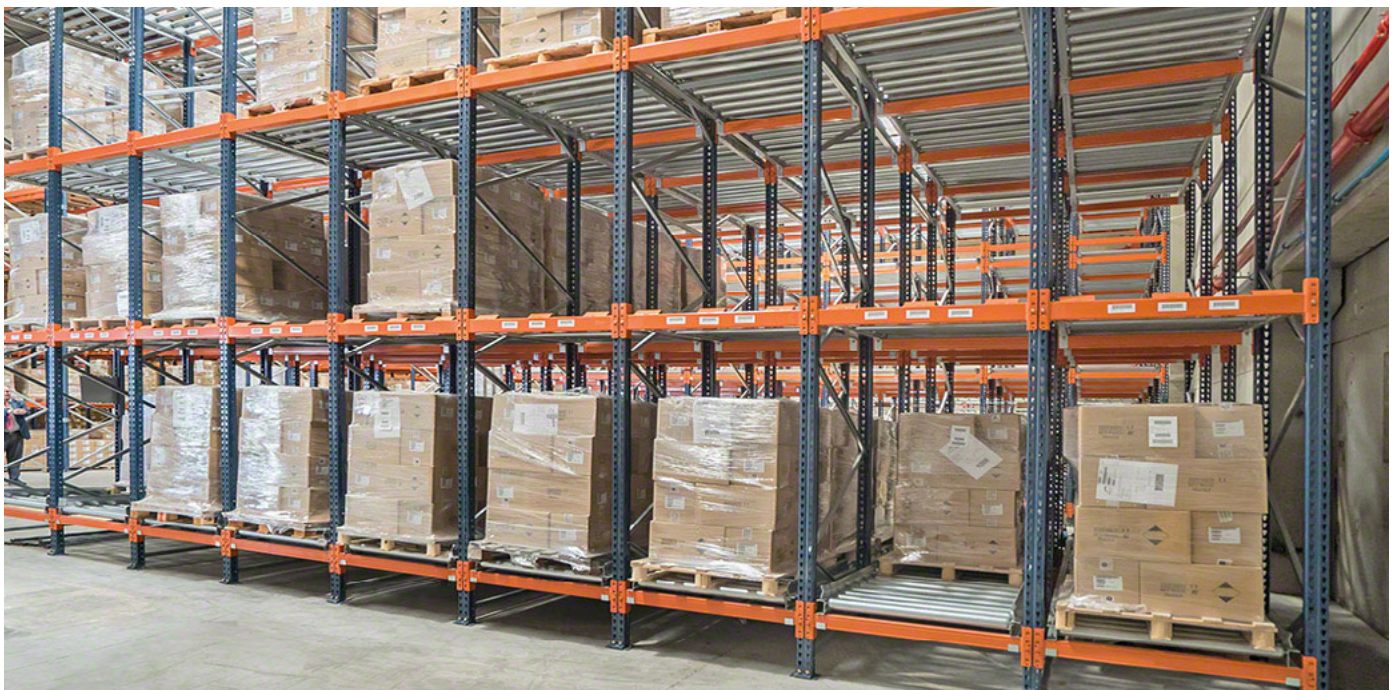

Push-Back Pallet Racking

- **Optimal use** of available space.
- Ideal for **storing medium-turnover products** with two or more pallets per SKU.
- **Minimal vertical space wasted** thanks to a specially designed system.
- **Each channel can store a different SKU.**



Push-back racking is an accumulative storage system that allows for storing up to four pallets deep per channel. All the pallets in each channel, except the last one, are placed on a set of carts (trolleys) that are pushed along rolling rails. These rails are built on a slight incline, with the front lower than the back, so that when the front pallet (closest to the aisle) is removed, the remaining pallets move forward. All the pallets placed on a particular level must contain the same SKU and are managed using the last in, first out (LIFO) method.





Cart and rail support

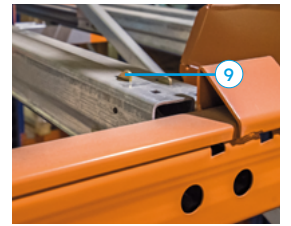

Lock trigger



Cart occupancy indicator



Pallet centraliser

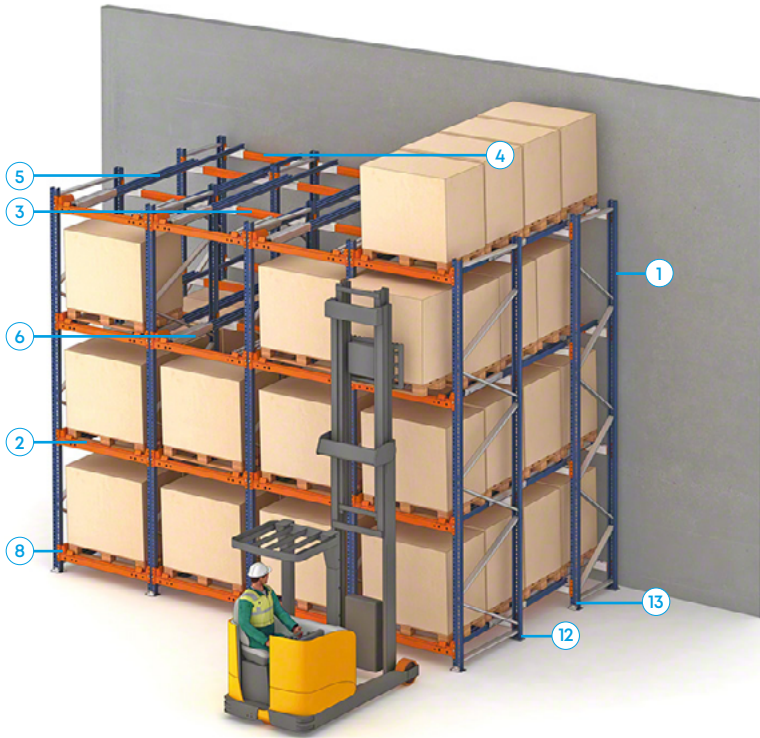

- | | |
|----------------------|------------------------------|
| 1. Frame | 8. Safety locking mechanism |
| 2. Front beam | 9. Lock trigger |
| 3. Intermediate beam | 10. Cart occupancy indicator |
| 4. Top beam | 11. Pallet centraliser |
| 5. Rail | 12. Supplementary plate |
| 6. Cart (trolley) | 13. Anchorage |
| 7. Rail support | |



Rack-Supported Warehouse

- **Space optimisation:** storage area is increased by eliminating intermediary pillars.
- **Quick implementation** with minimal construction: the racks themselves form the building structure.
- **High performance** facilities that can incorporate different degrees of automation.
- Ideal for freezer or **cold stores**.
- Both **automated** and **standard** systems can be implemented.



The rack-supported warehouse is the ideal solution for high-bay storage. Through its design, the racking structure forms a compact unit together with the facility's side and roof cladding, eliminating the need for separate building work.

In these works of engineering, the racking supports not only the entire framework and stored goods but also the movements of handling devices and external forces such as wind, heavy snowfall and seismic activity.

The height of these buildings is limited only by local regulations or the capabilities of the handling devices used.

These clad-rack warehouses allow for differing degrees of automation to guarantee optimal performance.



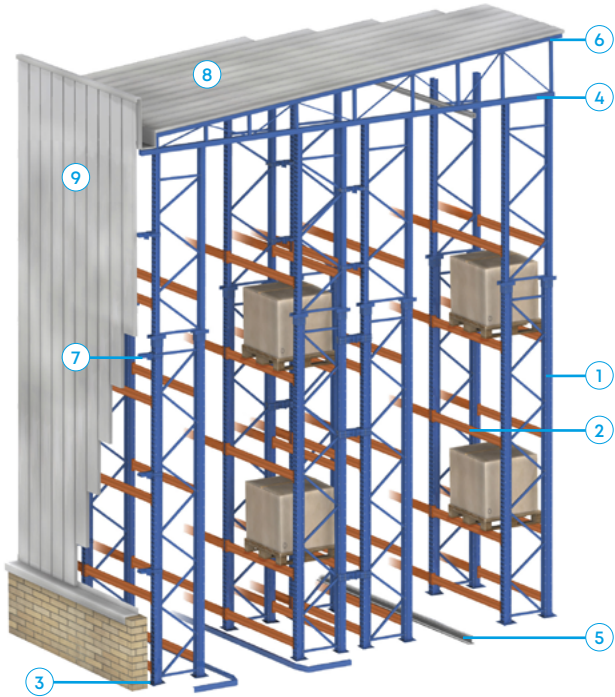

- 1. Frame
- 2. Beam
- 3. Footplates and anchor bolts
- 4. Roof trusses
- 5. Guide rails
- 6. Roof joist
- 7. Wall joist
- 8. Roof
- 9. Wall cladding



Automated Warehouses for Pallets

- Automation of product storage and retrieval operations.
- Elimination of possible errors arising from manual handling.
- Real-time inventory management.



Mecalux identifies the client's need and the required flow of stored goods to design the most appropriate automated storage and retrieval system (AS/RS).

In addition, Mecalux prepares the preliminary plans and manages the process from start to finish, taking care of the design, legal requirements, planning, assembly and completion of the AS/RS. The client communicates with a single contact person throughout the project.

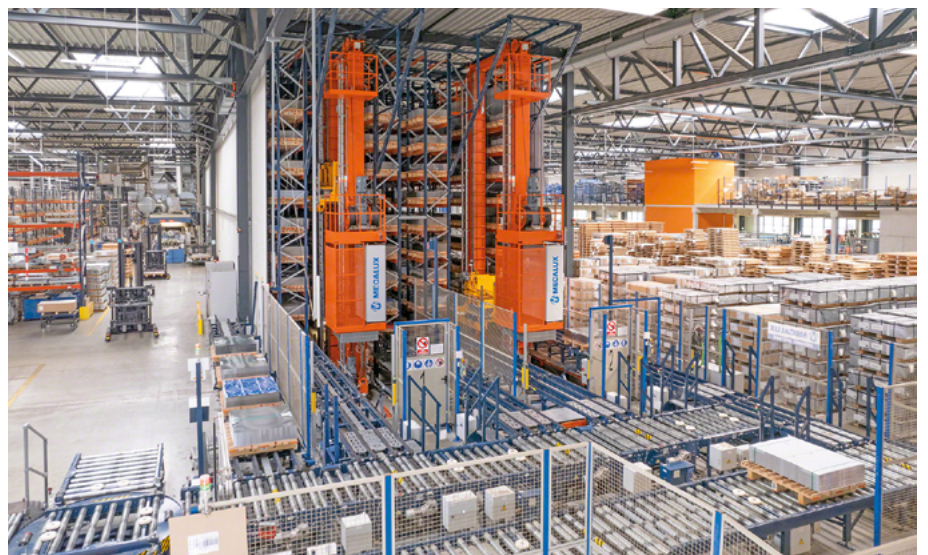

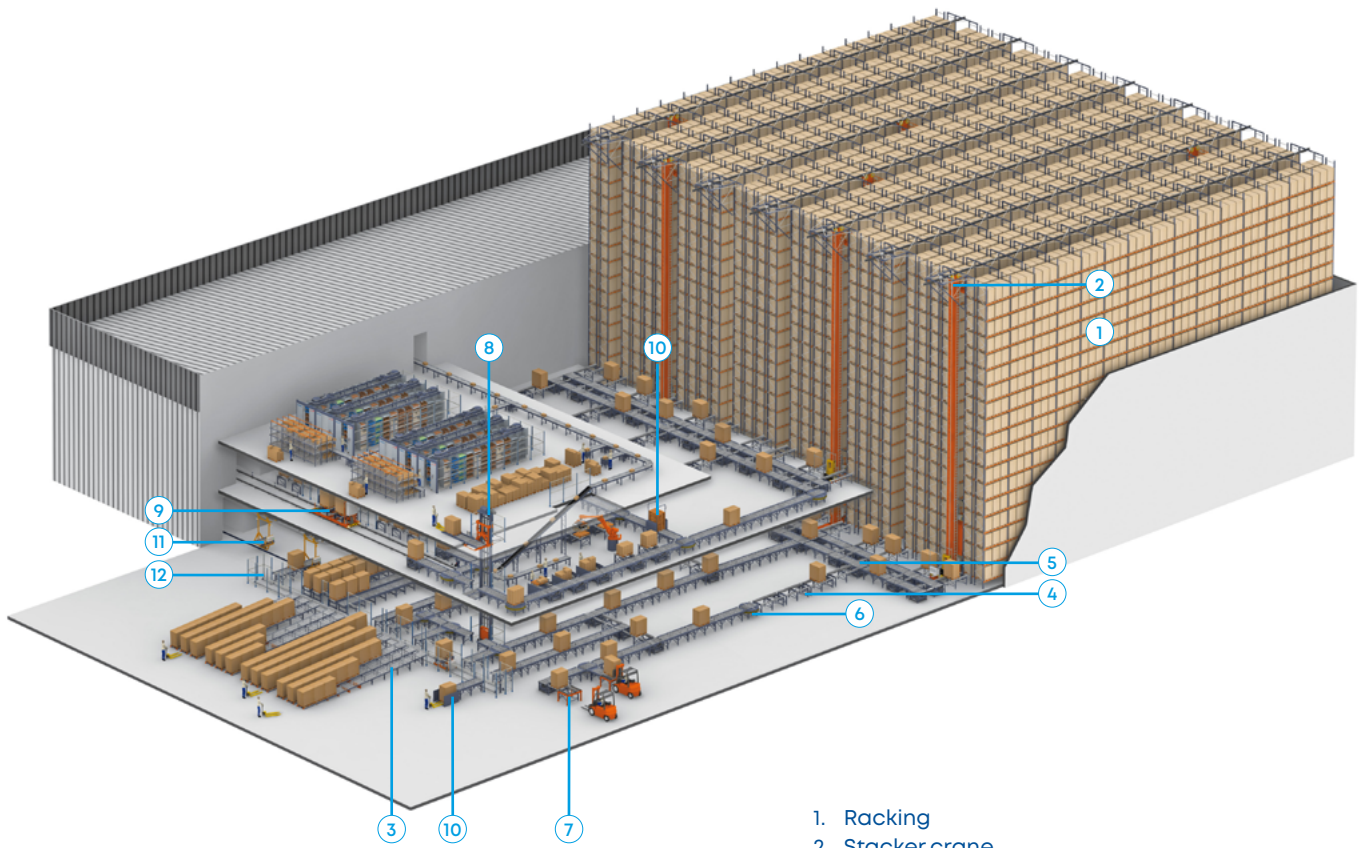

1. Racking
2. Stacker crane
3. Roller conveyor
4. Chain conveyor
5. Cross transfer roller & chain conveyor
6. Turntable conveyor
7. Input/output chain conveyor
8. Pallet lift
9. Transfer car
10. Pallet stacker/destacker
11. Electric monorail system
12. Safety and protection elements

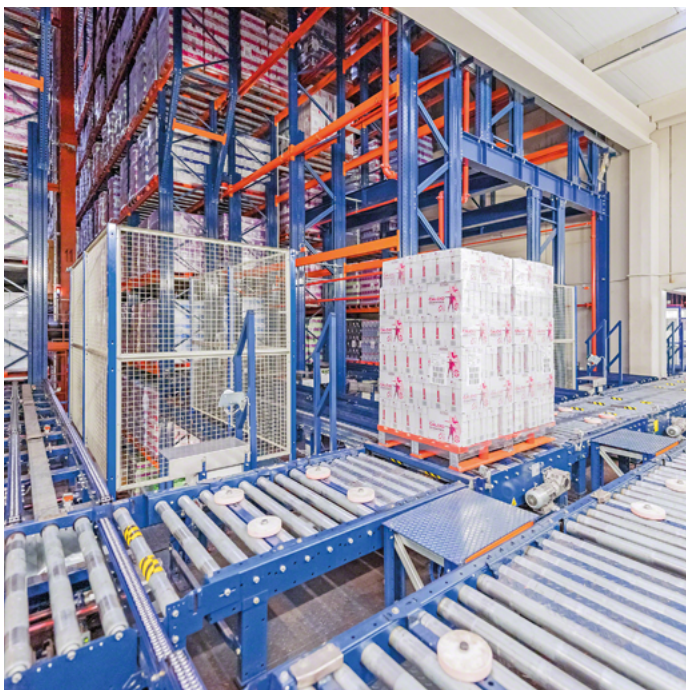

Stacker Cranes

- **Easily adaptable** to the needs of every warehouse in terms of load capacity, dimensions, design and cycle times.
- **Guided by management software** that coordinates all warehouse flows.
- **Automated extraction** of pallets in single, double or triple depth.



Stacker cranes are machines designed to automate the storage and retrieval of materials via automatic mechanical operations. Goods are inserted and removed in the same movement (i.e. a combined cycle). This increases the productivity of the AS/RS and reduces the resources required for it to function.

They are guided from above by a profile attached to the racking and from below by a rail anchored to the floor.

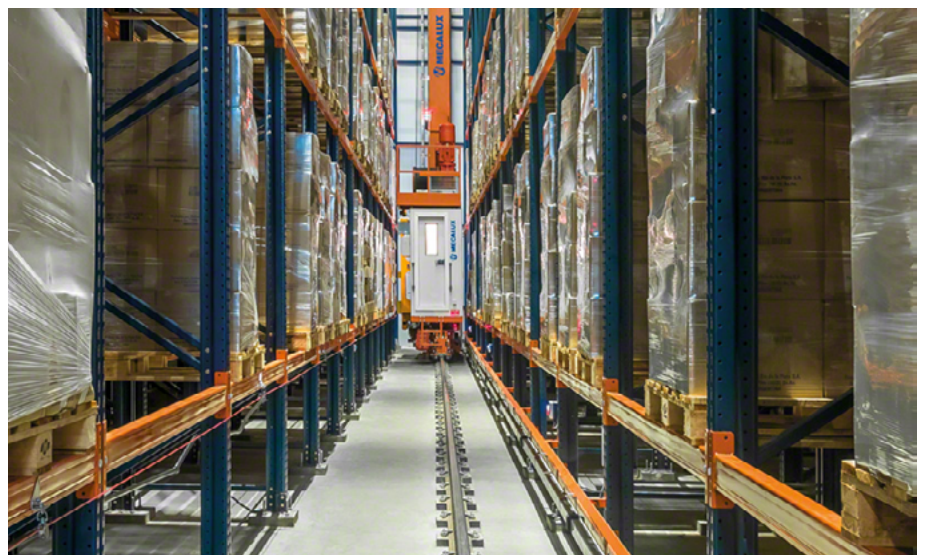

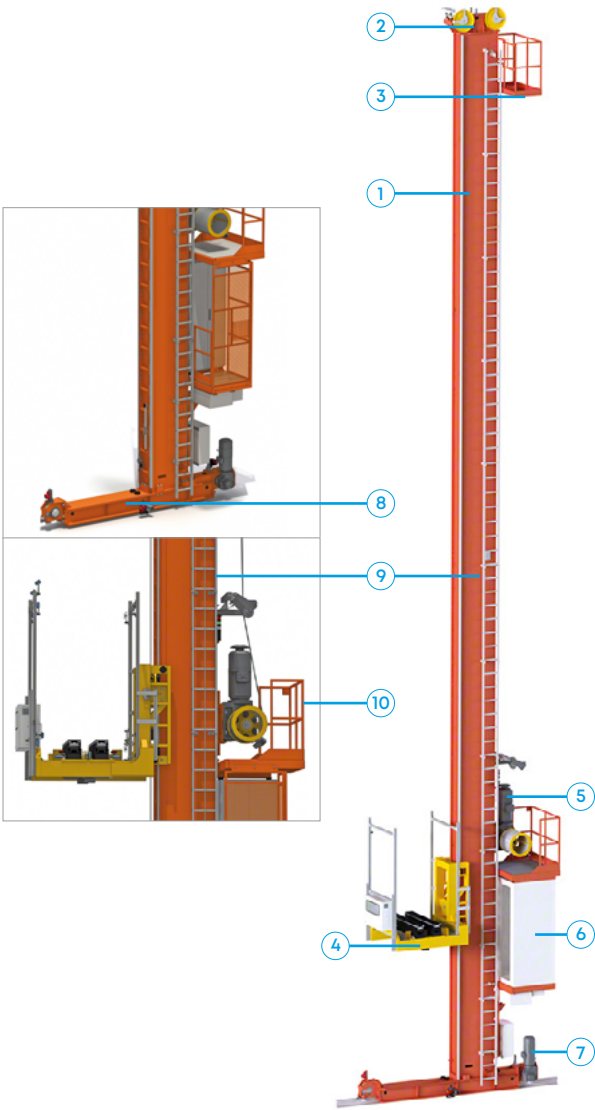

1. Mast
2. Upper guide base
3. Maintenance platform
4. Lifting cradle
5. Lift motor
6. Electrical cabinet
7. Travel motor
8. Lower guide base
9. Ladder
10. Safety railing

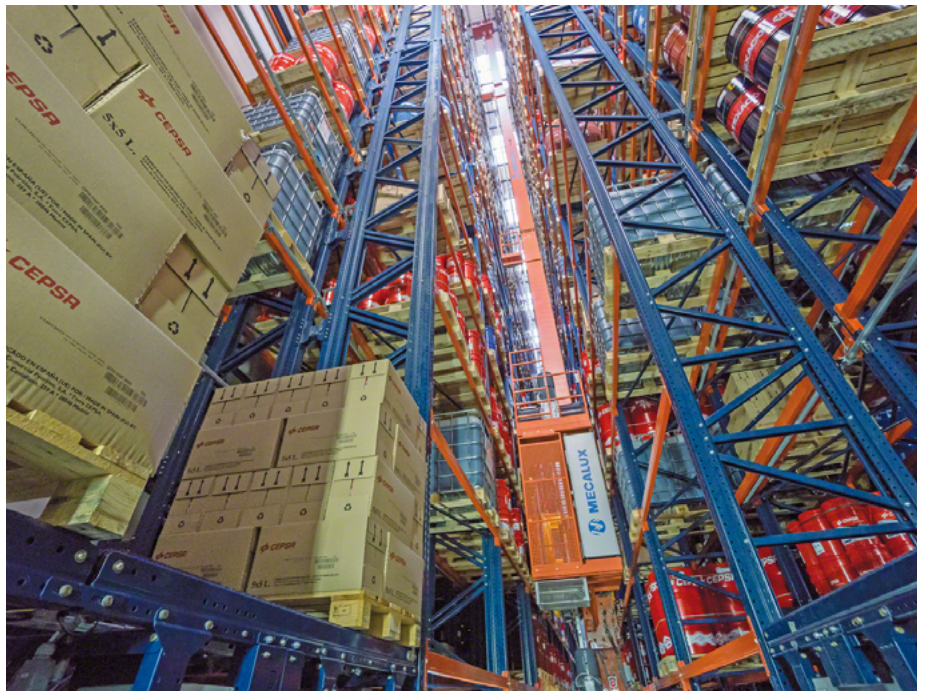
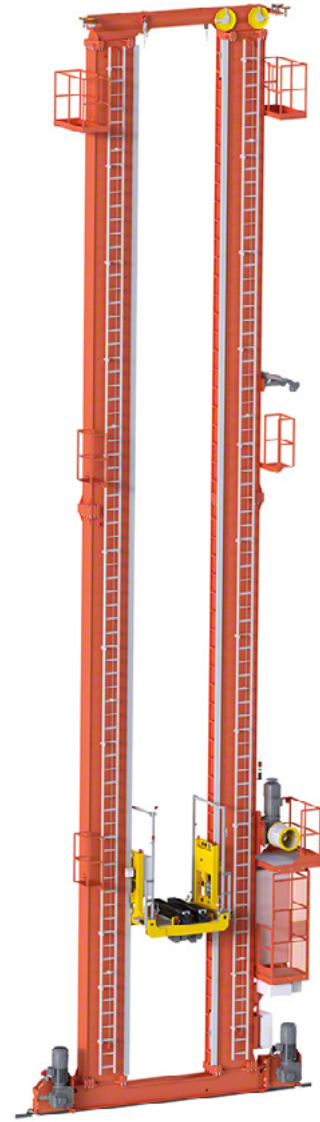

Automated Pallet Shuttle

- **Greater storage capacity.**
- **Automated management** and error elimination.
- **Enhanced productivity** with an increase in cycles/hour.
- **Cost savings** in labour, energy and surface area built.
- Possibility of grouping **a different SKU in each storage channel.**
- **Lower risk of accidents** and absolute control over goods.



This solution incorporates automated equipment in the handling processes of high-density storage systems. Forklifts are replaced by stacker cranes or transfer cars, which carry the Pallet Shuttle and the load in their cradle.

The shuttle enters the storage channels and positions each pallet in the innermost available space, following the orders issued by Mecalux's Easy WMS warehouse management system.



Structure

1. Upright
2. Beam
3. Rail
4. Inner rail support

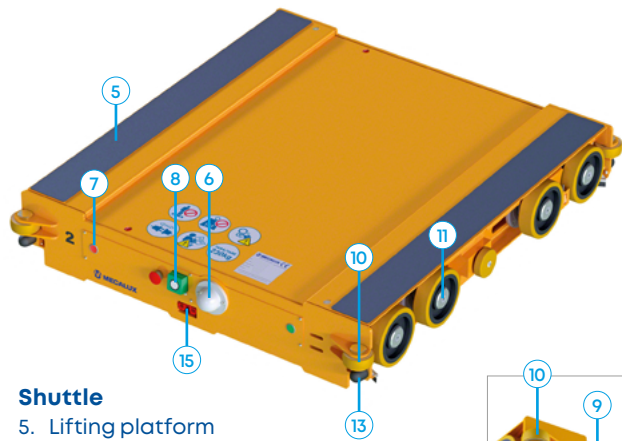
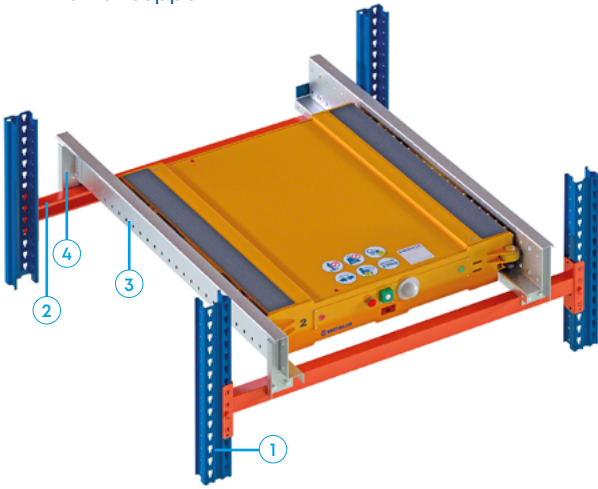

Shuttle

5. Lifting platform
6. Antenna
7. Fault indicator
8. Ultrasound sensors
9. On/off switch
10. Guide wheel
11. Running wheel
12. End-of-track sensors
13. Rubber stop
14. Automatic battery connectors for supercapacitors
15. Connector for supercapacitor discharge

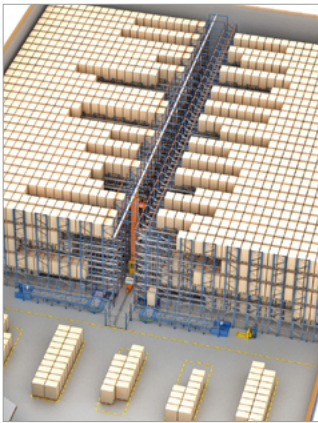
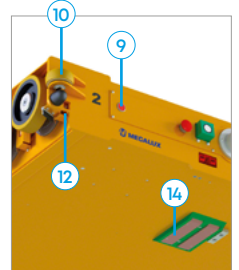

Automated Pallet Shuttle system with stacker crane
The stacker transports unit loads from the AS/RS input and output points to any storage channel. The Pallet Shuttle is tasked with moving the pallets from the stacker crane's cradle to the location in the corresponding channel. Generally, two high-density storage racking blocks are installed, one on each side of the working aisle.

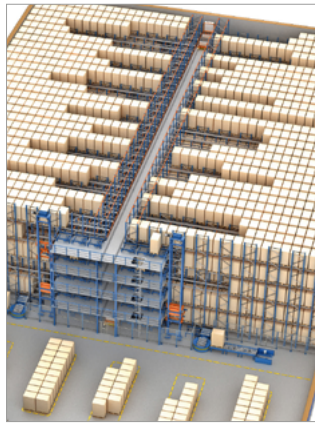

Automated Pallet Shuttle system with transfer car
A gangway-type structure is installed to enable a transfer car to operate on each level, moving unit loads from the lifts to the storage channels. Thus, the number of movements (cycles/hour) is multiplied by the number of levels in the AS/RS, combining high capacity with an increased flow activity.

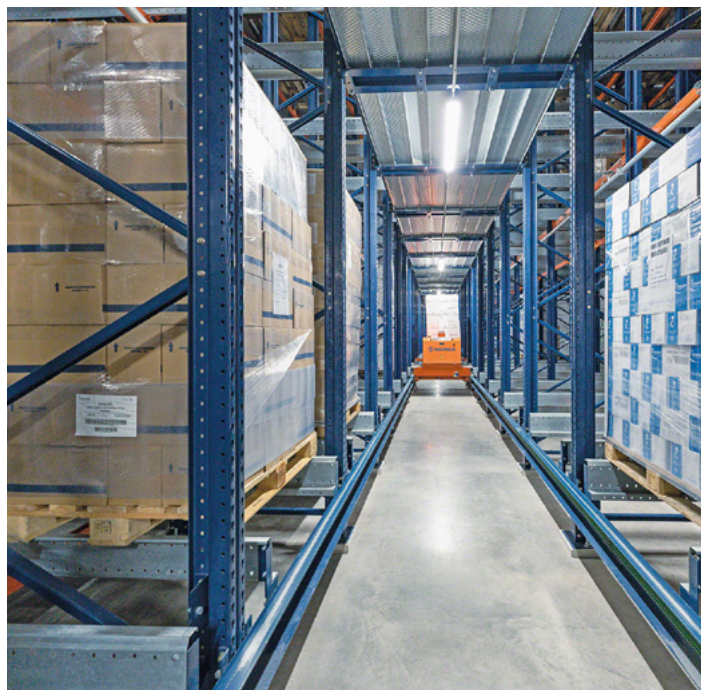

3D Automated Pallet Shuttle

- **High productivity** thanks to the speed and operational versatility of the shuttle cars.
- Increased storage capacity through space maximisation.
- Each channel can house more than one SKU.
- **Autonomous, smart operation.**
- Scalability: the AS/RS's modular design facilitates its future expansion.
- The system provides significant **energy savings**.



The 3D Automated Pallet Shuttle is a high-density storage solution featuring an innovative multi-directional electric shuttle. This autonomous shuttle car stores and retrieves pallets from racking with unparalleled efficiency and precision. Notably, these shuttles navigate the aisles and channels within the racking structure independently, eliminating the need for additional material handling vehicles (e.g. stacker cranes or transfer cars). To move between storage levels, the shuttles employ a series of lifts.



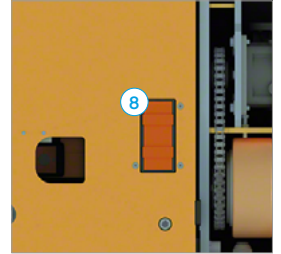
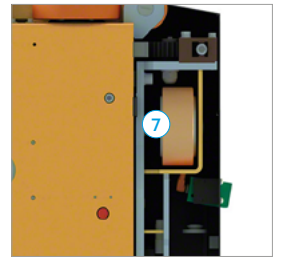

1. Lifting platform
2. Antenna
3. Sensors
4. Channel running wheels
5. Channel guide wheels
6. Aisle running wheels
7. Aisle guide wheels
8. Battery

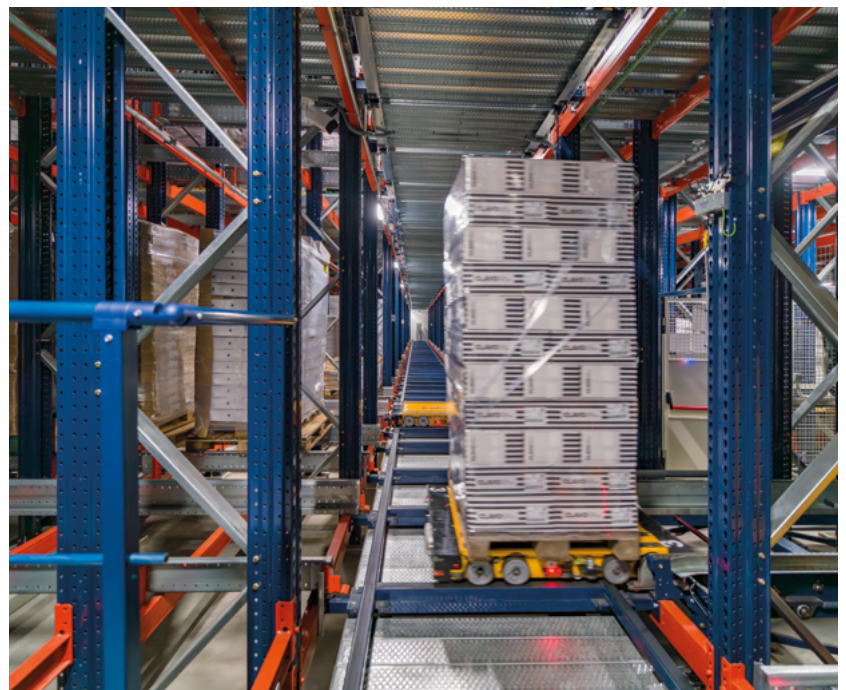
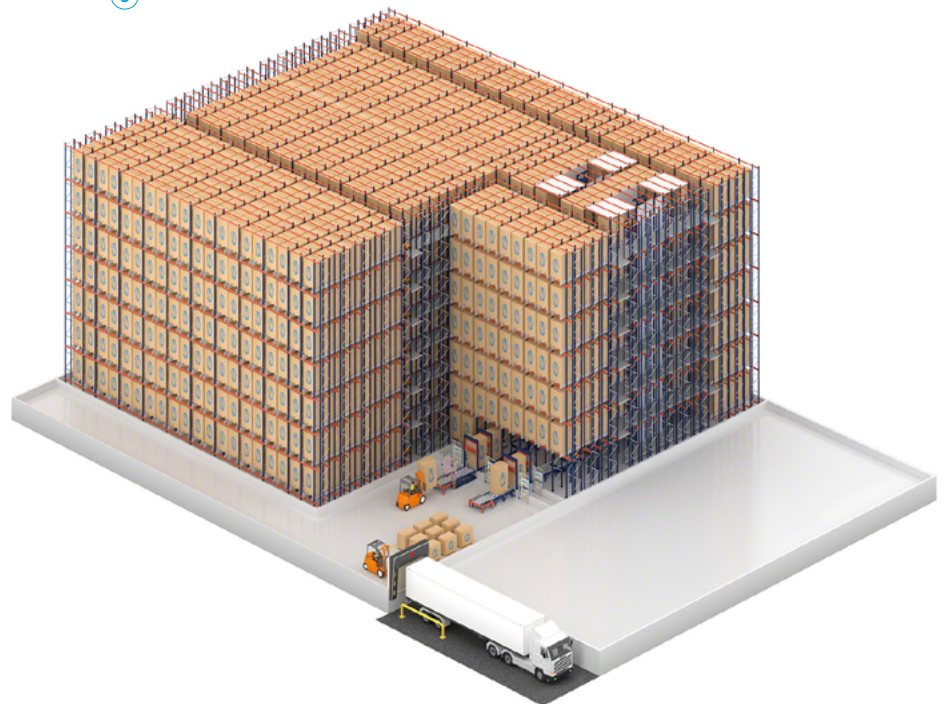

Automated Trilateral Stacker Cranes

- The perfect solution for **automating pallet racking** up to 15 m high.
- **Easy implementation** with no need to modify the warehouse structure.
- Integrated **trilateral extraction** system.
- **Lower personnel costs and reduced errors.**
- **Improved safety** in the facility.
- **Low maintenance costs.**

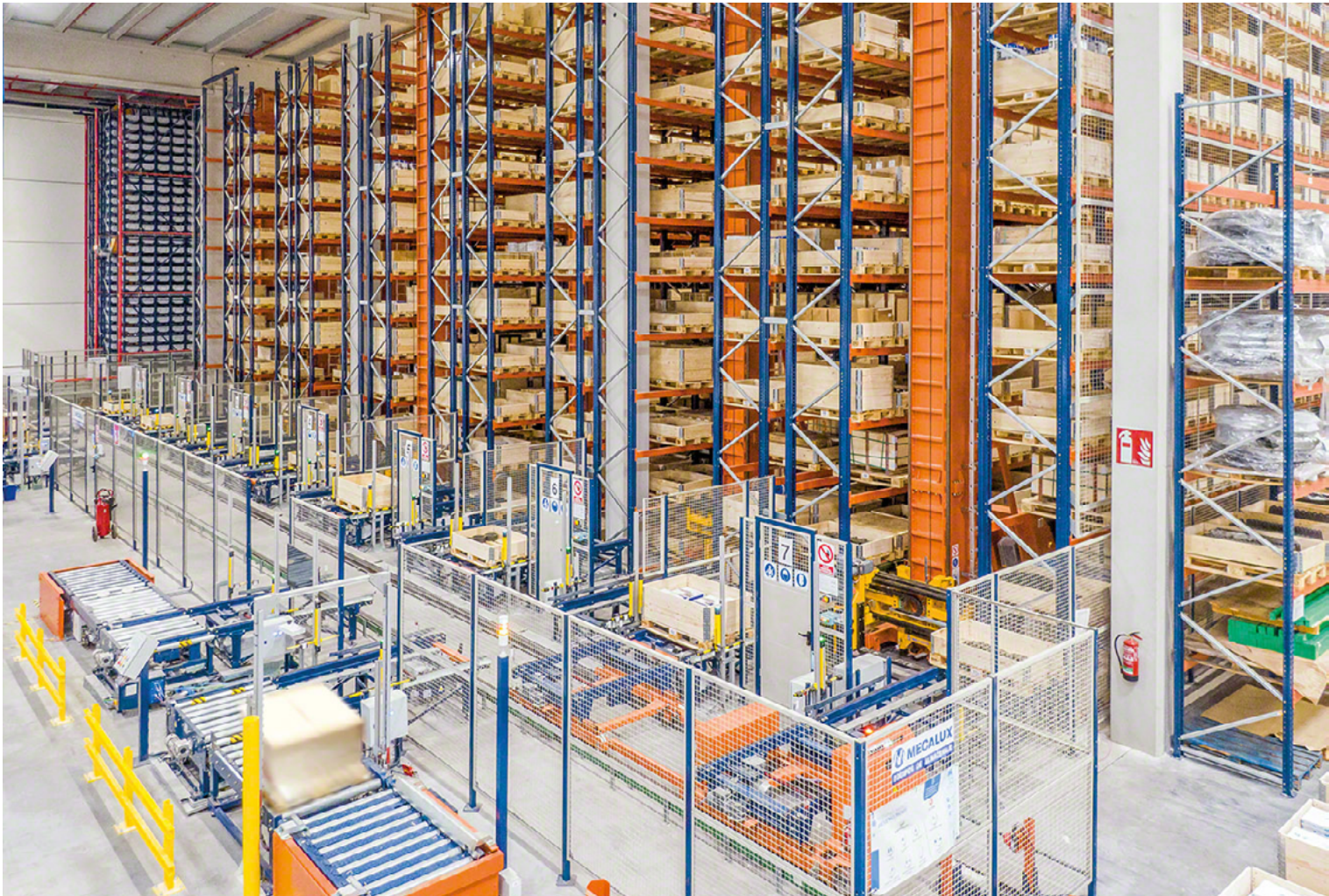

Automated trilateral stacker cranes simplify the automation of conventional racking systems typically operated with manual lift trucks, both in pre-existing warehouses and new facilities.

The stacker crane moves pallets to the ends of the aisle, leaving the load on a P&D station or another automated transport system. This is possible through its rotating head, which enables it to pick up and set down pallets in three positions: one frontal and two lateral.

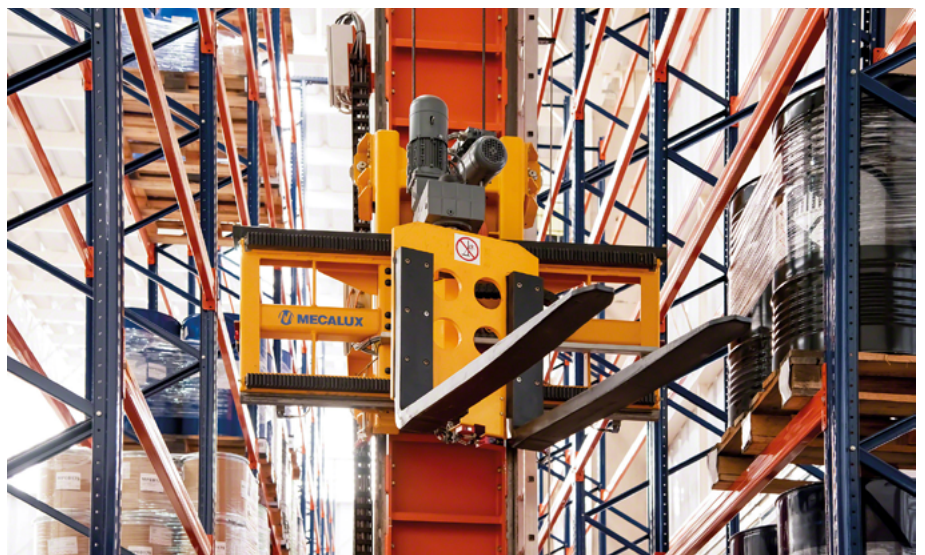

It consists mainly of three parts:

Bottom guide base.

Component that supports the whole structure and moves it longitudinally.

Column. Element that allows the crane to reach different heights.

Extractor element. Trilateral fork moved by a head that can travel left, right and forward to access the load.

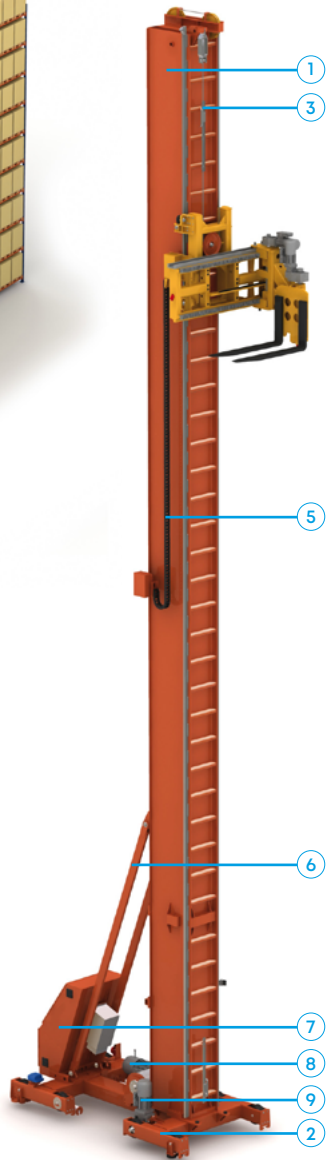
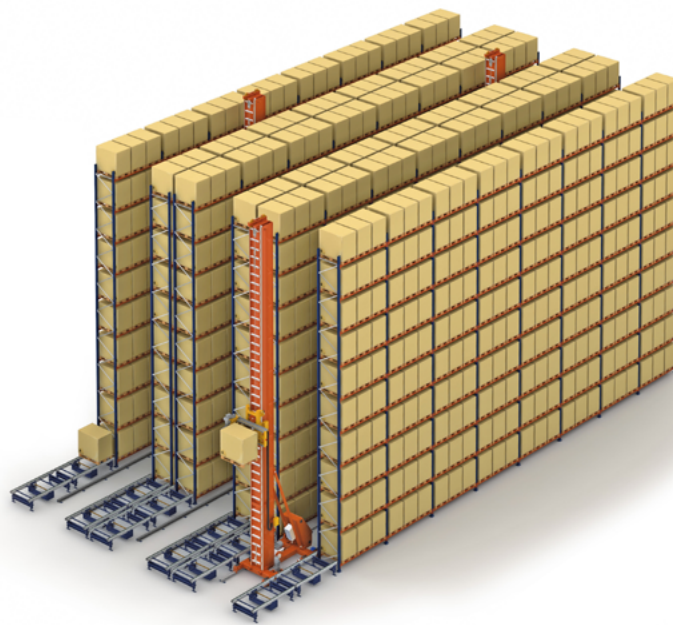

- 1. Column
- 2. Bottom guide base
- 3. Lifting cable
- 4. Trilateral extractor
- 5. Cable carrier
- 6. Cross bracing
- 7. Electrical cabinet
- 8. Lift motor
- 9. Travel motor
- 10. Extraction motor

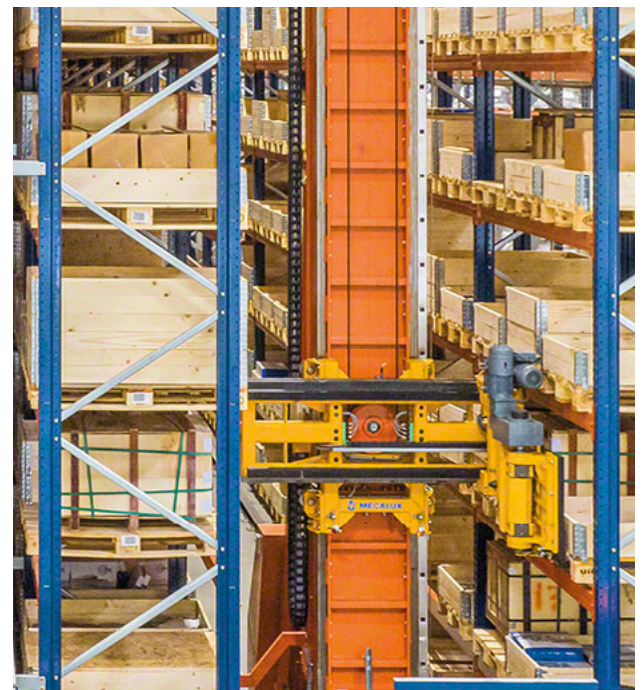
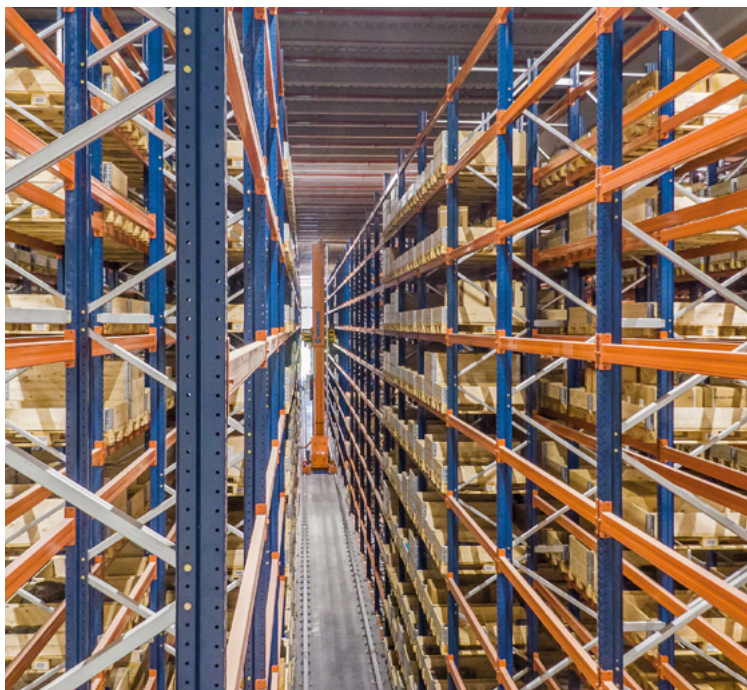
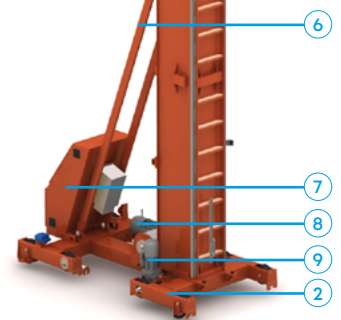
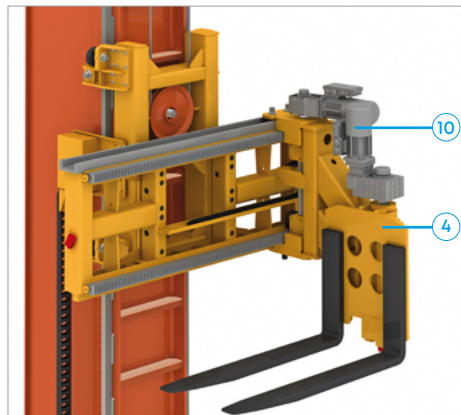
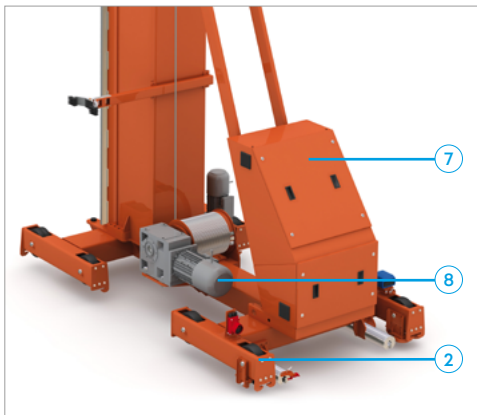

Pallet Conveyor Systems

- **High productivity** in storing and retrieving products.
- **Reduction of mistakes and accidents** thanks to automated material handling.
- **Wide range of items** allowing for different combinations.
- Maximum **standardisation of conveyor measurements and components**.



Logistics operations require a continuous flow of materials, with pallets and/or boxes moved from storage, production or buffer locations to shipping or manufacturing areas. Conveyors offer an ideal combination of stacker crane efficiency with goods receipt, dispatch and handling processes.

These static transport devices incorporate a series of rollers or chains. Electric-powered motors move pallets in a continuous, controlled manner.

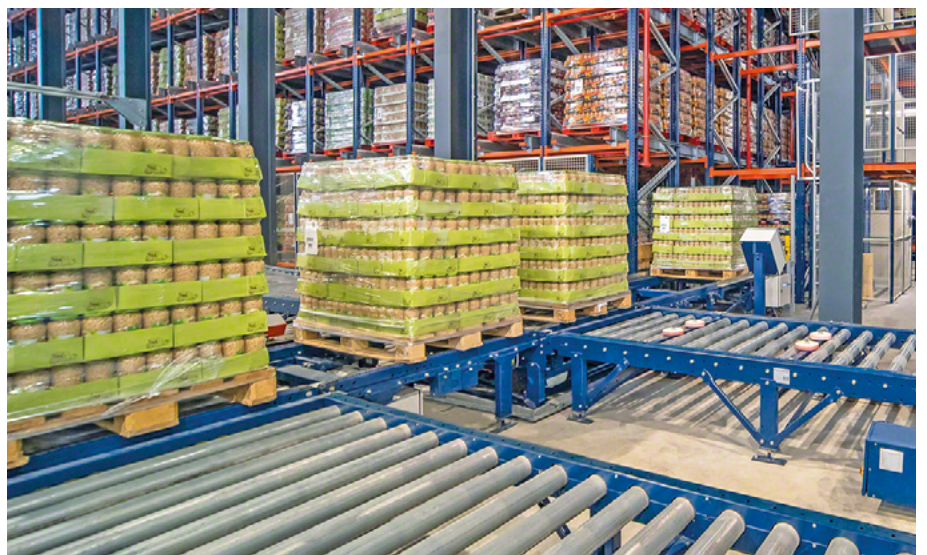

Here are some examples of Mecalux conveyors:

1. Roller conveyor
2. Chain conveyor
3. Pallet inspection station
4. Pallet lift
5. Turntable conveyor
6. Cross transfer roller & chain conveyor
7. Transfer car
8. Chain conveyor for side loading
9. Roller conveyor for front loading
10. Lift table
11. Pallet stacker

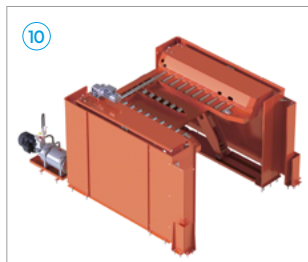
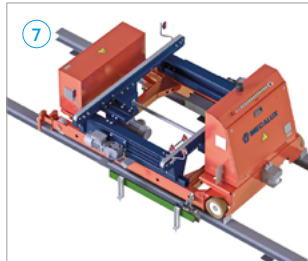
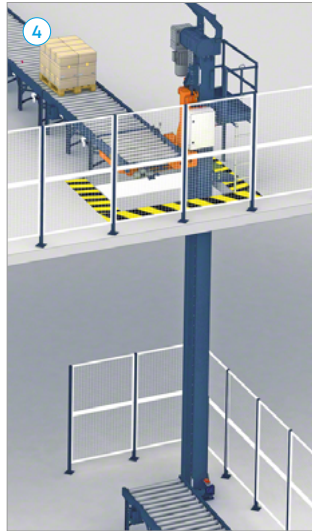

M7 Heavy Duty Storage Racks

- Optimal solution for manually storing and archiving **varied products**.
- Ideal for accommodating **bulky** or **heavy items**.
- **Adjustable load levels**.
- Wide range of **components adaptable** to client needs.



M7 Heavy Duty Storage Racks are designed for warehouses where goods are deposited and removed manually from shelves. This system makes optimal use of warehouse height, as the higher levels can be accessed mechanically by stacker cranes, devices that lift operators to the required height (order pickers) or gangways installed between shelves.

It is also common practice to set up a mixed warehouse of picking and pallet storage, where the top shelves hold palletised reserve stock and the bottom section is set aside for picking.



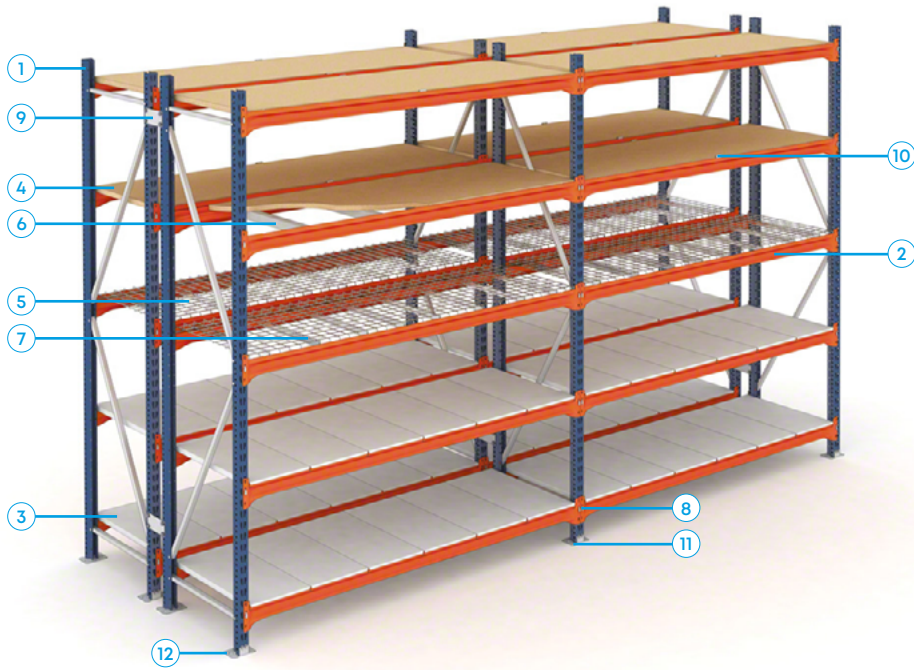

Units for hanging products.
There are two solutions for hanging garments or other items: one formed by hanger tube beams and another in which shelf levels are combined with supports and hanger tubes.

1. Frame
2. Beam
3. Galvanised picking shelf
4. Chipboard shelf
5. Mesh shelf
6. Chipboard cross-tie
7. Mesh shelf cross-tie
8. Safety pin
9. Frame union
10. Z-TAM Clamp
11. Shim (levelling plate)
12. Anchor bolt (if applicable)

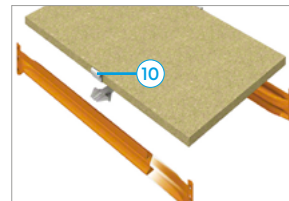

Chipboard shelf

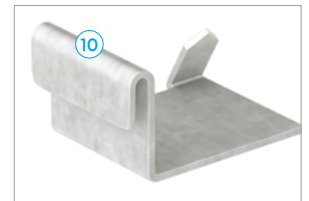

Z-TAM Clamp



Pick Modules

- **Maximum use of warehouse height.**
- **Possibility of installing** one or more gangways.
- **Accessibility to different levels** via stairs.
- Gangways can be placed on **any existing rack model.**



The warehouse's full height is utilised by installing high-bay shelving with one or more gangway levels supported by the racks themselves.

Access to the different levels is provided by strategically placed staircases, ensuring safety and convenience.

In addition to the stairs, goods lifts or lifting platforms can be installed.

Several types of flooring (e.g. wood, slotted metal, perforated) are available to suit different needs.



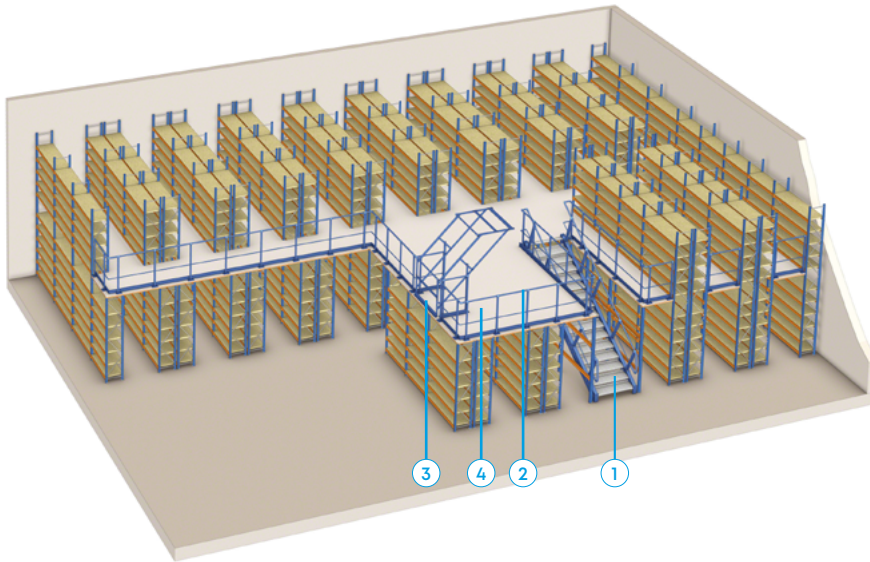

1. Stairway
2. Railing
3. Up-and-over gate
4. Floor



Stairways. Stairs designed by Mecalux are easy to assemble, robust and adaptable to different heights.



Railings. Protective rails are built with round and rectangular tubes joined together. Protective skirting is fitted to the base to prevent objects from falling from the mezzanine floor.



Up-and-over gate



Swing gate



M3 Light Duty Racks

- **Simple system for manually storing** and archiving light and medium loads.
- **Multiple modules** adapt to the most demanding requirements.
- Possibility of installing one or more **gangways to access upper levels**.
- **Easy assembly**.



Manual storage system designed to accommodate individual products or goods in small boxes.

These strong, durable, highly versatile structures are compatible with a wide variety of needs, including e-commerce order picking, product display and document archiving.

Various accessories allow for the division of levels and placement of boxes to classify individual products, folders, hanging items, etc.



1. Frame
2. Shelf
3. Shelf supports
4. Cross bracing set
5. Frame union
6. Footplate
7. Back panels (in sheet metal or mesh)
8. Shelf retainer
9. Plinth
10. Vertical divider
11. Drawers
12. Doors
13. Suspension filing set
14. Garment rail set
15. Side hooks
16. Magnetic label holder

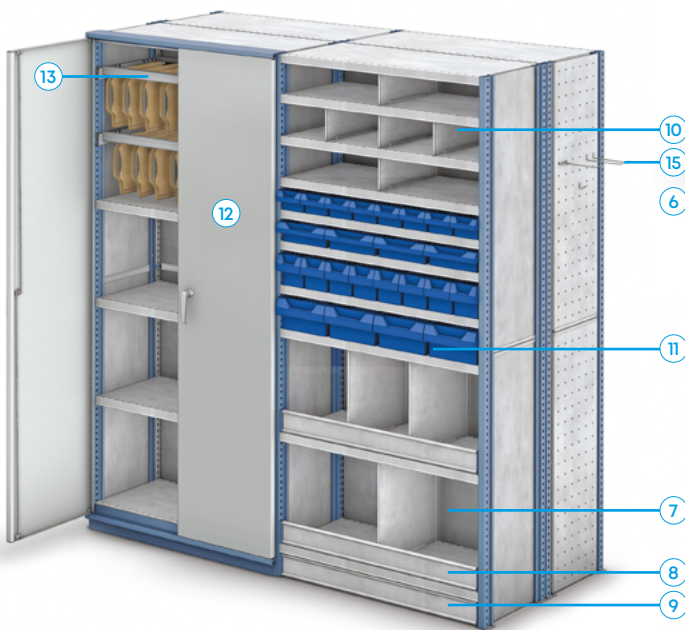
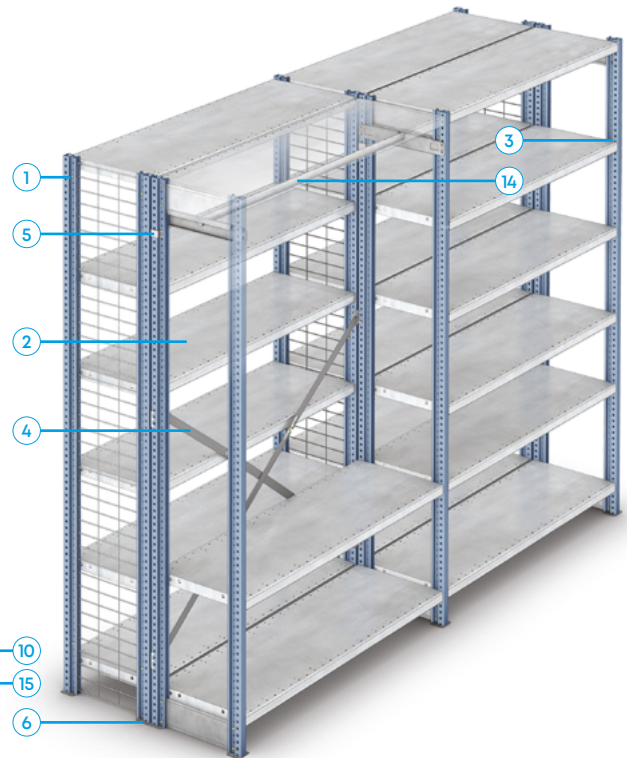

HM metal shelf



HL metal shelf



Live Storage for Picking

- FIFO (first in, first out) system for flawless product turnover.
- **Larger number of SKUs** at the front of the racking.
- **Faster** order picking.
- **High storage capacity.**



Live storage for picking. Goods are placed onto sloped roller tracks where they then roll at a controlled speed towards the lane exit by the force of gravity.

This guarantees perfect product turnover, avoids interference between inventory replenishment and picking and enables quicker order processing. To speed up picking, pick-to-light solutions managed by the warehouse management system can be incorporated.



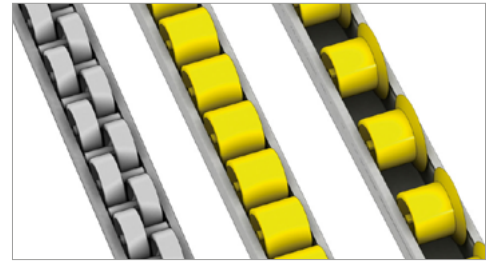
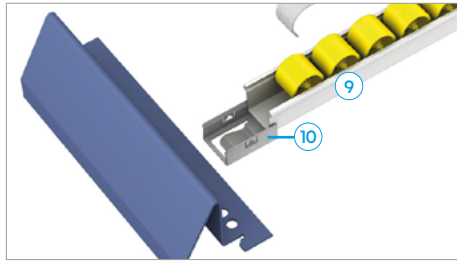
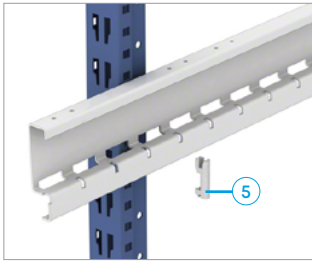

Mini-rails

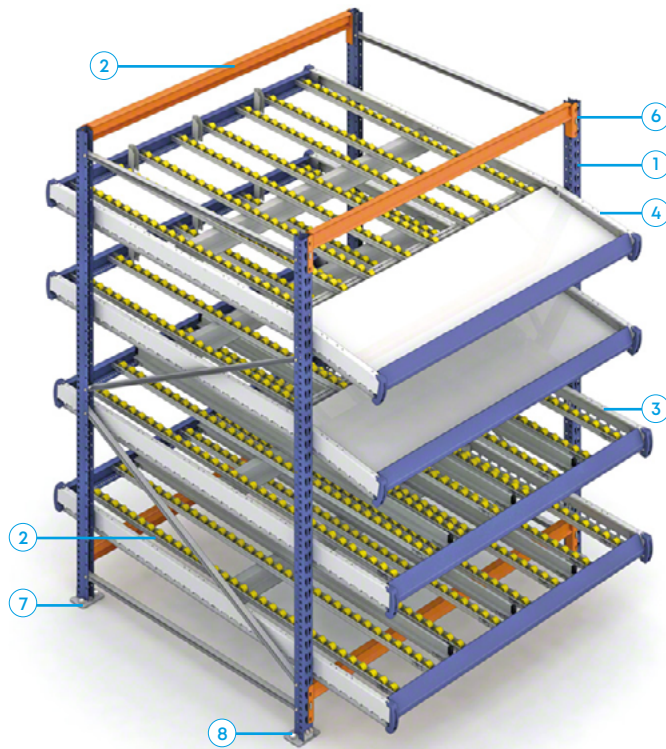

1. Frame and upright
2. Beam
3. Standard bed frames
4. Bed frames with display trays
5. Frame supports
6. Safety pins
7. Anchor bolts
8. Levelling plates (shims)
9. Mini-rails
10. Mini-rail clips



Automated Warehouses for Boxes

- **Automation** of product storage and retrieval operations.
- High **productivity**.
- **Optimal use** of available space.
- **Elimination of errors** arising from manual management.
- **Real-time inventory**.
- Maximum **convenience and easy access** to stored boxes.



Optimal for putaway and picking according to the goods-to-person principle. These automated storage and retrieval systems (AS/RSs) consist of one or more aisles with racking on both sides for housing boxes, bins, totes or trays. A stacker crane moves up and down each aisle, inserting and removing unit loads from their locations.

Conveyors are installed in the picking and handling area, located at one end or next to the racking structure. Stacker cranes deposit loads extracted from the racks on the conveyors, which deliver them to operators. Once picking has finished, the conveyor returns the totes to the stacker cranes, which place them in their correct positions in the racking.





Racking

Designed specifically for high-bay storage of boxes and other small unit loads, the racking aligns seamlessly with the stacker crane's movements. Its configuration improves space utilisation and increases storage capacity.

Stacker crane

This automated element stores and retrieves boxes in the racking, in addition to transporting and placing them on conveyors at the front or to the side of the AS/RS.

AS/RS workstation

Located at the side or front of the racking, this workstation handles inbound and outbound flows from the AS/RS. Unit loads are moved mechanically to operators for picking or back to the stacker crane to be returned to their position in the AS/RS.

Warehouse management system (WMS)

This software runs and supervises all storage operations, optimising the use of time and warehouse space. The WMS streamlines logistics process management and provides easy access to all information in real time.

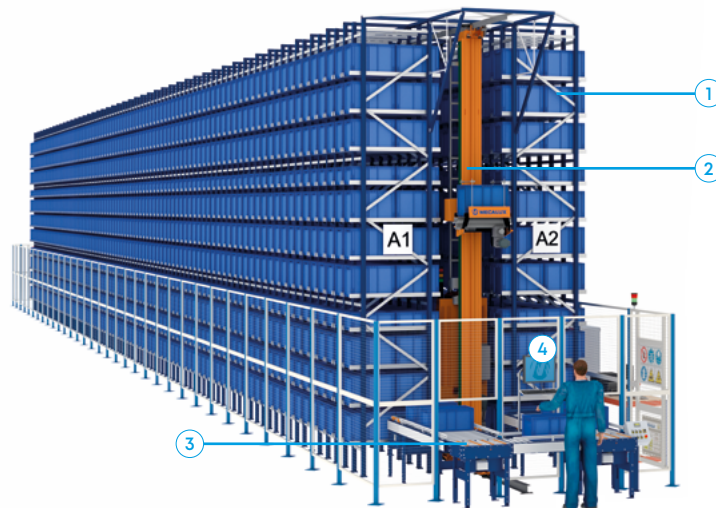

- 1. Racking
- 2. Stacker crane for boxes
- 3. Workstation
- 4. WMS



Stacker Cranes for Boxes

- **Swift, reliable** box storage and retrieval.
- **Automation of product entry and exit** operations.
- **Elimination of errors** resulting from manual management.
- **Inventory management control.**

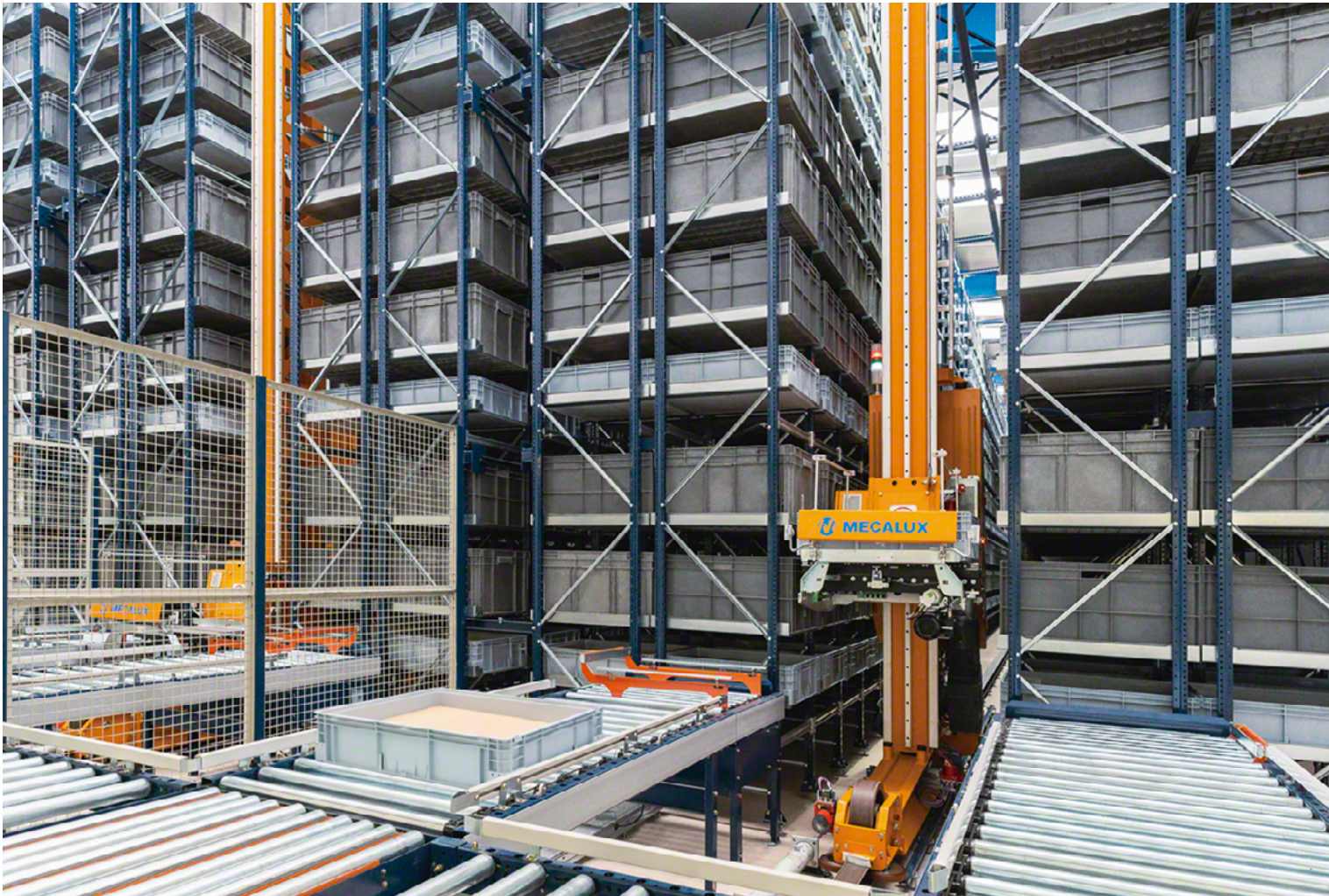

Stacker cranes for boxes are designed to achieve high productivity in managing boxes, bins, totes and trays.

The design of the stacker cranes minimises the forces transmitted to the supporting structure, thus preventing long-term damage to the racking or the structure of the storage system.

Mecalux has also equipped its machines with the essential ergonomic and safety systems needed to carry out work orders and maintenance as easily as possible.



1. Bottom guide base
2. Column
3. Top guide base
4. Lifting cradle
5. Electrical box
6. Lifting mechanism
7. Travel mechanism
8. Cable-free electrical conduction
9. Ladder

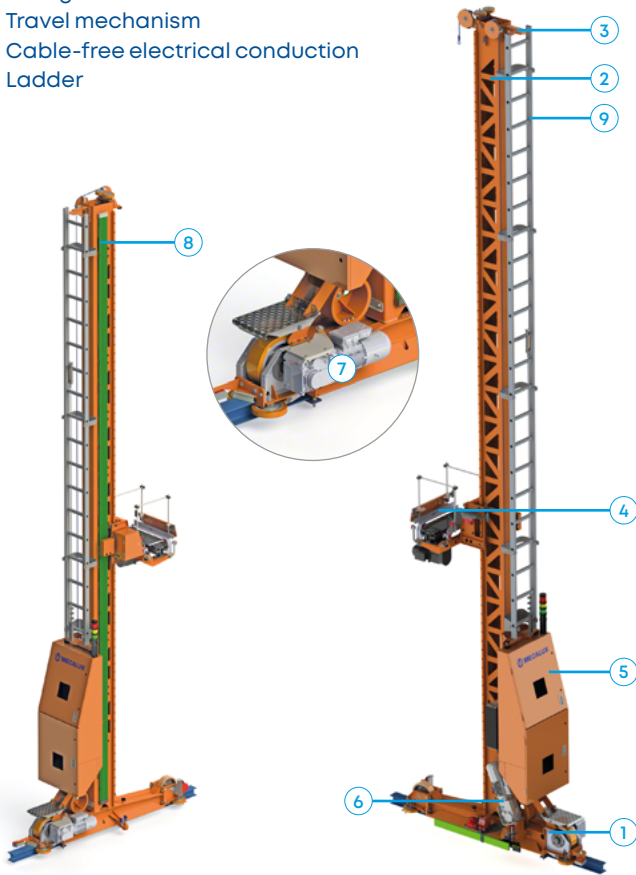

ML50 single-mast stacker crane
It can handle a box of up to 50 kg at a height of 9 m.

ML100 single-mast stacker crane
It can reach up to 12.3 m high and transport two 50 kg boxes.

MLB100Q twin-mast stacker crane
It can reach up to 20 m high and handle two 100 kg unit loads or four 50 kg unit loads.

MLHP single-mast stacker crane
It can reach up to 21 m high and transport two 50 kg unit loads.

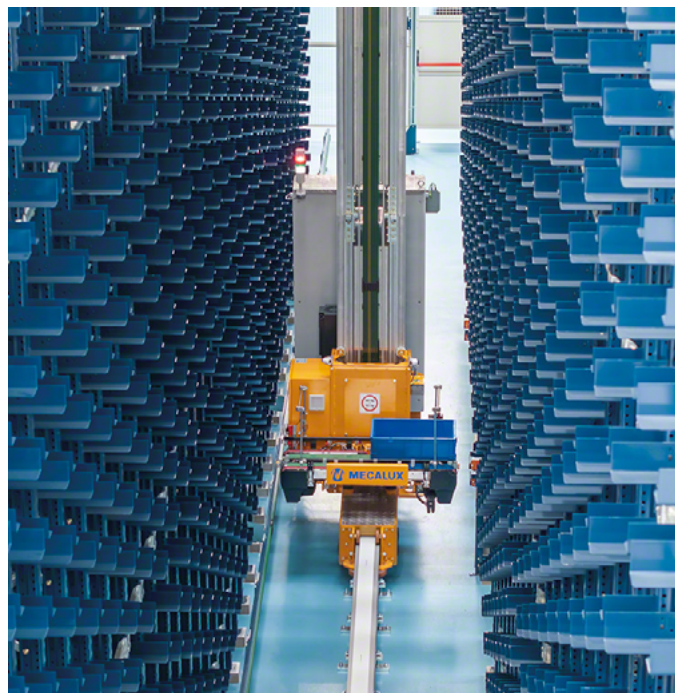

Shuttle System

- High number of **movements/hour**.
- **Maximum speed** in product storage and retrieval.
- **Continuous flow** and operation (24/7).
- Perpetual (real-time) inventory.
- **Modular and scalable** based on logistics needs.
- **Optimisation of available surface** space to expand storage capacity.



This automated storage and retrieval system (AS/RS) for boxes is ideal for high-throughput distribution centres.

The solution features shuttle cars that streamline order picking, ensuring a constant flow of products from AS/RS storage locations to pick stations.

It is adaptable to different unit loads: cartons, plastic totes and metal trays of multiple sizes.



1. Racking
2. Motorised shuttle
3. Box elevator
4. Conveyor system
5. Warehouse management system
6. Pick stations

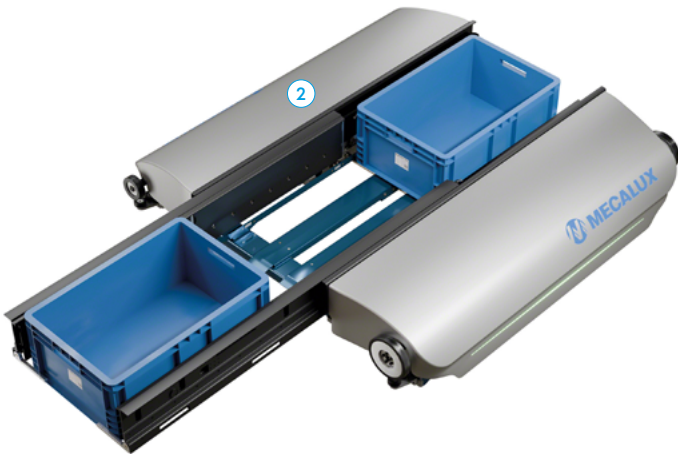
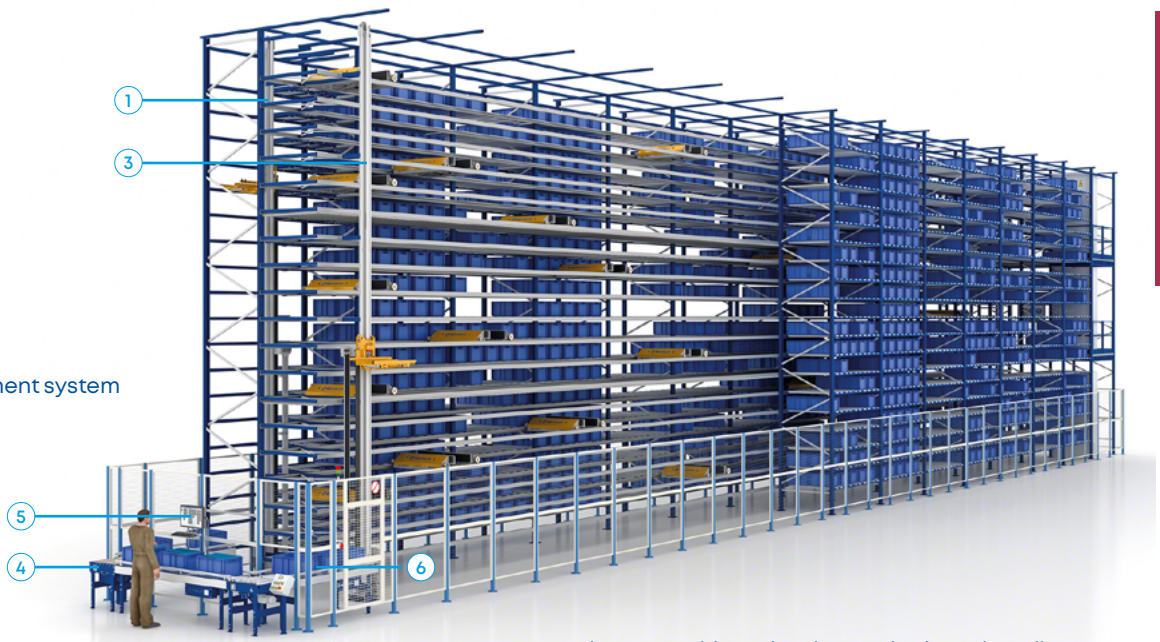

The motor-driven shuttle travels along the rails at a **speed of 4 m/s**.

The **lifts** located at the ends of the AS/RS have an acceleration of **8 m/sec²**.

Thanks to its **sensors**, the electric shuttle detects its position and moves to the assigned location with full autonomy.

The operation of the shuttle is **controlled by an onboard PLC**.

The shuttle's **telescopic arms** perform storage and retrieval operations in single-, double- or triple-deep racking.

On each level, the motorised shuttle can move **up to 2 totes, each weighing 50 kg maximum**.

The system can incorporate a **lift for the shuttles to change levels**.



High-Performance Pick Station

- **Goods-to-person** delivery system.
- **Pick-to-tote order picking.**
- **Ergonomic** design: adjustable platform height.
- **High throughput**, with up to 1,000 picks/hour per person and station.
- **Error elimination.**
- Protection and **safety** for operators and goods.



Mecalux's high-performance pick station is designed to boost order picking. It provides operators with immediate and direct access to as many boxes or totes as possible when filling orders.

This solution is ideal for high-turnover products, and thanks to its ergonomic design, it facilitates the preparation of up to 6 orders at a time.

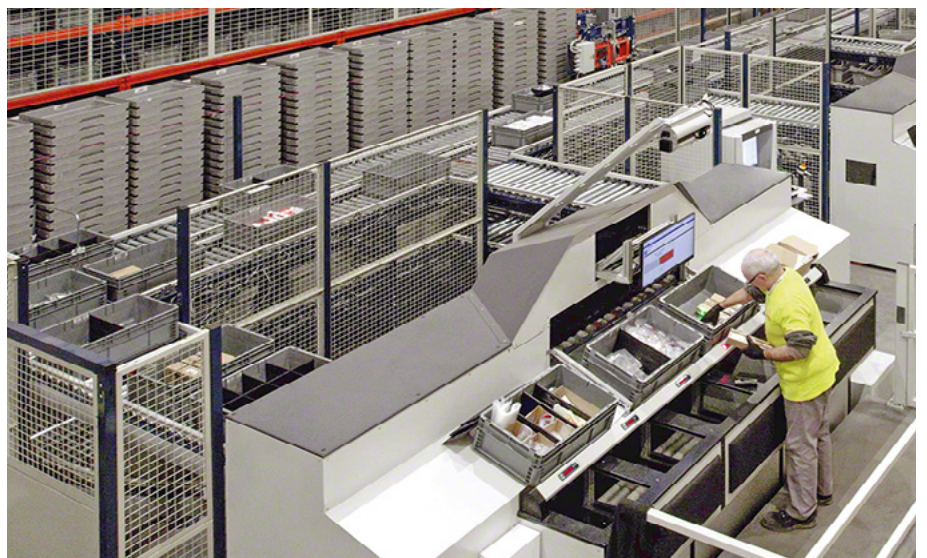

1. Storage totes containing SKUs
2. Order totes
3. Conveyor system
4. Warehouse management system
5. Lifting platform

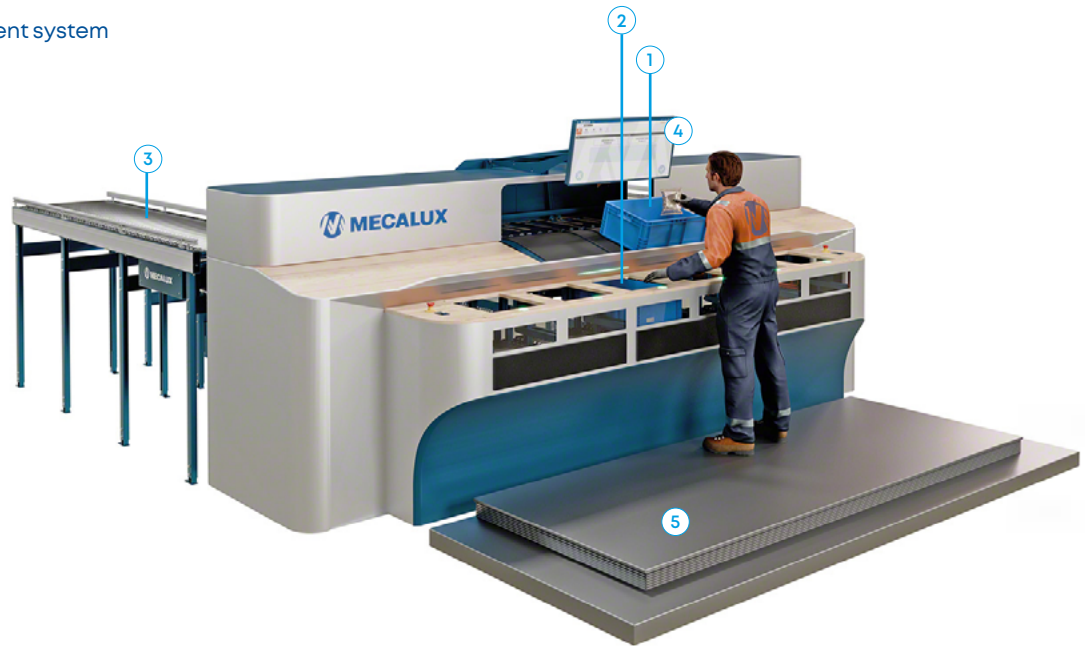

Operation

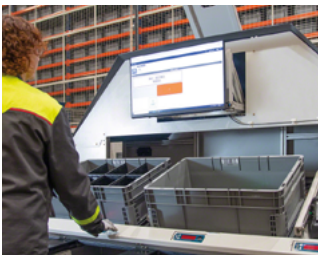

1. The operator consults the instructions from the Easy WMS warehouse management system on the monitor directly in front of them. The WMS indicates which item and how many to remove from each tote.



2. The operator then picks the items and distributes them into the corresponding order totes. If the fulfilment workstation incorporates pick/put-to-light systems, these will provide operators with additional information on how to fill orders.



3. Once all the necessary products have been picked, the storage totes at the top of the pick station are automatically removed and sent back to the AS/RS.



4. When the order is completed, the order tote on the lower level is moved to the consolidation area and replaced with another empty tote to fill a new order.



Picking Robot

High-performance system: up to 1,000 picks/hour.

- **Goods-to-robot** order picking.
- Management of a wide variety of items with different shapes, surfaces and dimensions.
- Absolute **precision** in picking.
- **Autonomous** operations.

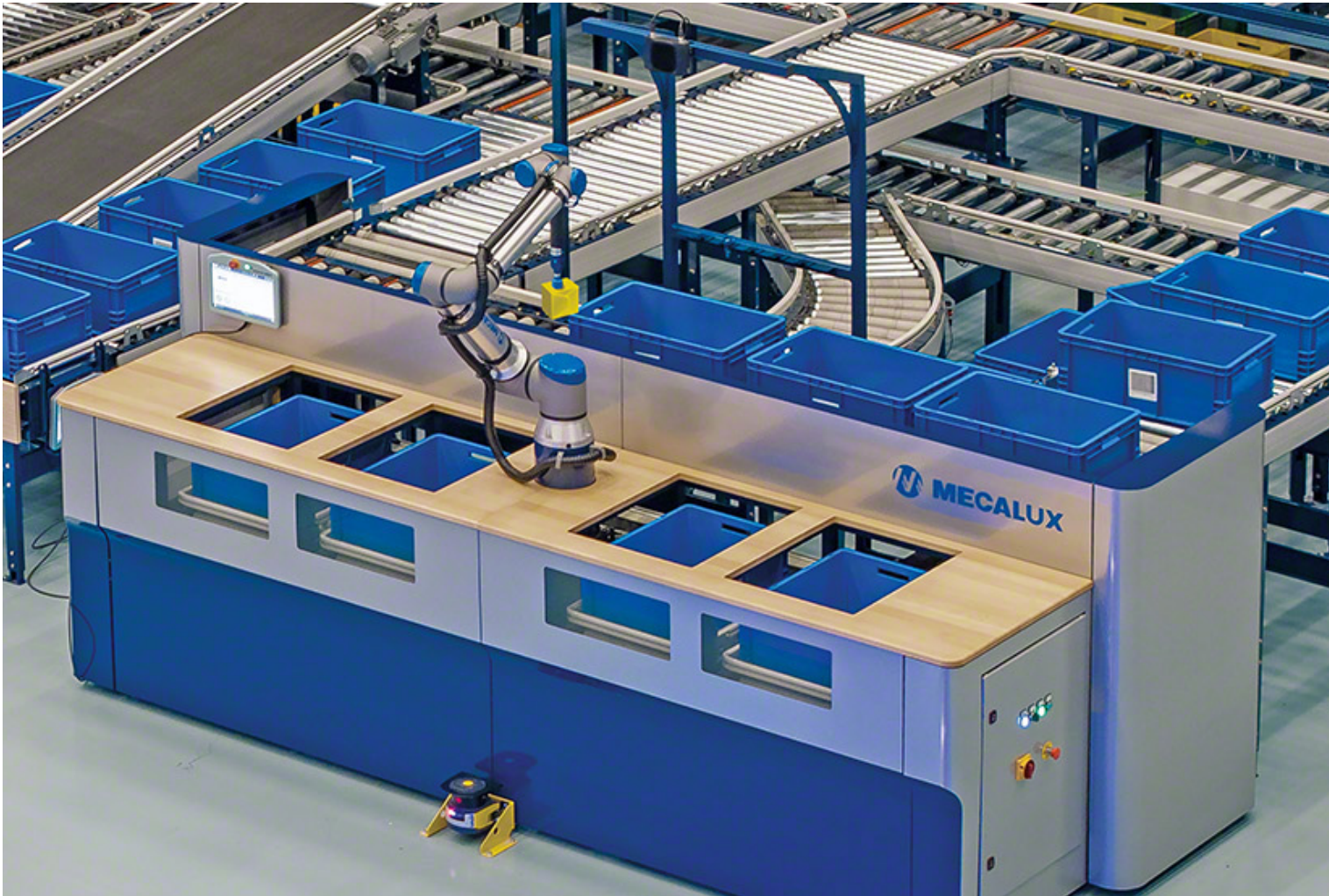

The picking robot is a pick-and-place cobot designed to automate order picking. It retrieves products from one storage tote or bin and places them into another autonomously. Thanks to innovative deep learning-based vision software and a highly versatile gripping device, the robot handles a wide variety of items with absolute precision, regardless of their sizes, shapes or finishes.

The cobot can detect the presence of any person or object in its vicinity and adjust its working speed, making its environment extremely safe.





1. Camera
2. Arm
3. Gripping device
4. Vision software
5. Rotoscan

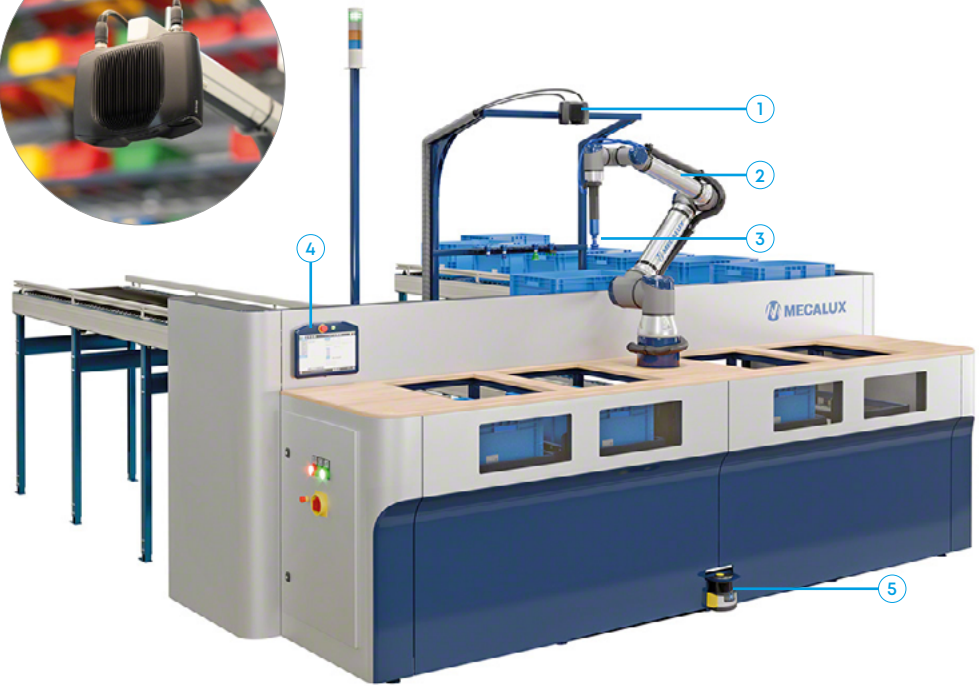

Arm. Compact, high-performance robotic arm with a gripping device integrated at the end. It provides maximum operational efficiency and a long reach of up to 1,300 mm.

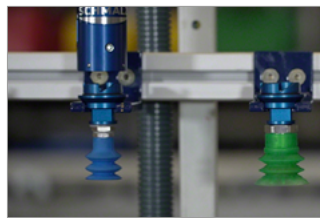

Gripping device. Versatile, lightweight vacuum gripper that adapts to items of various shapes, surface finishes, weights and dimensions. It grips products optimally, ensuring delicate handling to prevent any damage during pick-and-place operations.



SIMATIC Robot Pick AI vision software (from Siemens). Processes the image captured by the camera. With an extremely high degree of precision, it determines the optimal picking point and the best orientation for the gripping device.

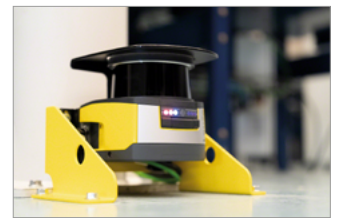

Rotoscan. Laser scanner that activates the reduced work mode when it detects the presence of an operator in the robot's operating area. This mode slows down the cobot's speed to prioritise the safety of humans in its vicinity.

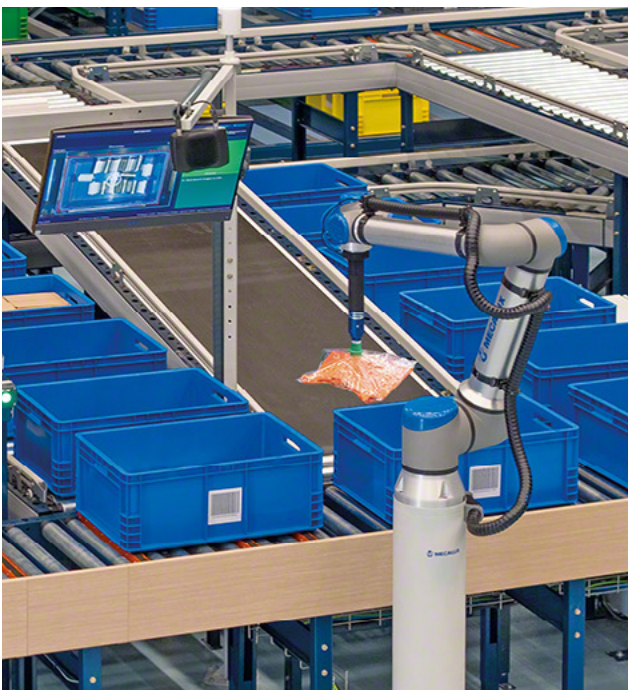

Box Conveyor Systems

- Robust system designed to withstand **daily high-performance operations**.
- **Ergonomic, compact design** that facilitates interactions between the machine and operators.
- **Low maintenance** and easy order processing.
- **Reduced operating cost**.



The automatic transport of light loads is typically linked to high product turnover, which can only be achieved through the seamless integration of all system components.

This continuous internal transport solution can be scaled to meet client growth requirements.



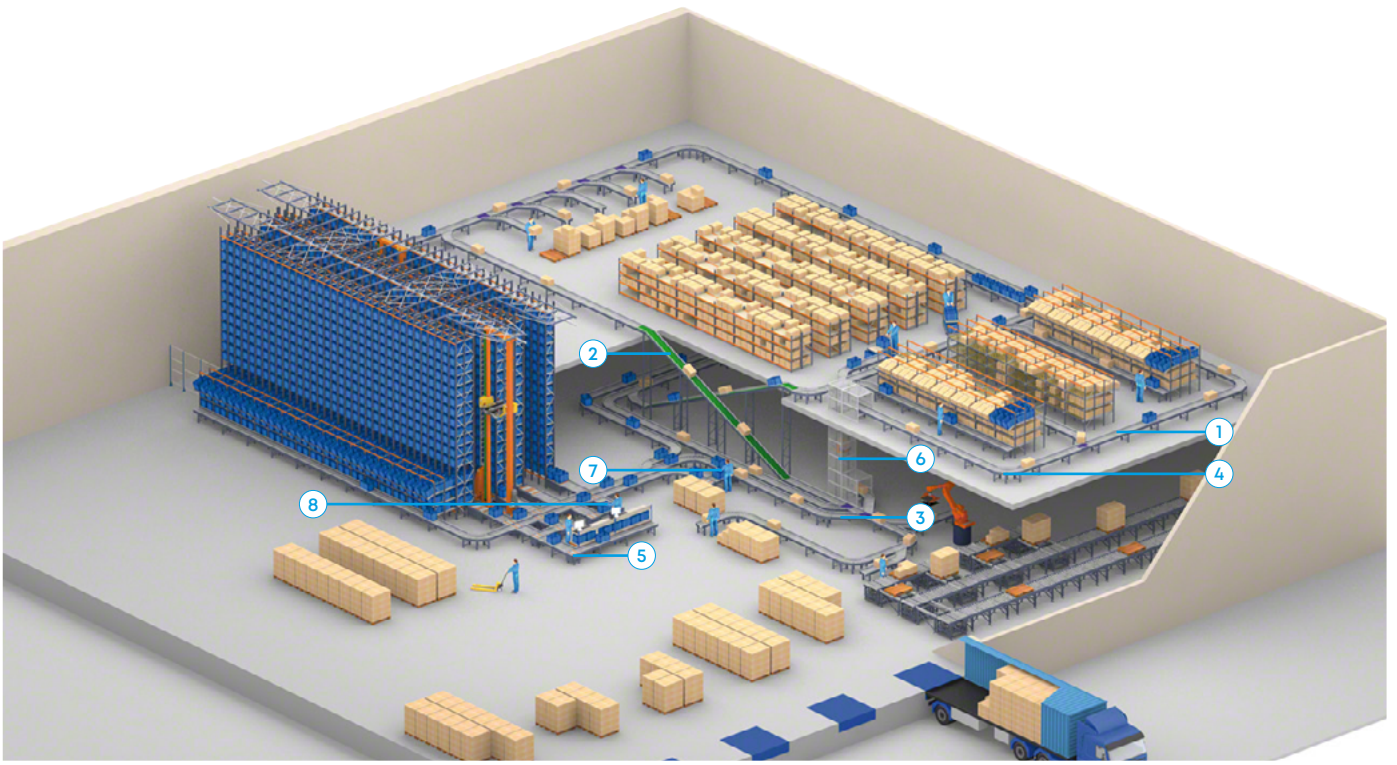

1. Roller conveyor
2. Belt conveyor
3. Diverter conveyor
4. Curved roller conveyor
5. Cross transfer roller & toothed belt conveyor
6. Continuous lift
7. Assembly and verification station
8. Pick station



Roller conveyor
Designed to move unit loads in a straight line and can also perform accumulating functions.

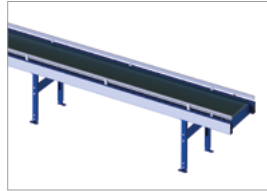

Continuous belt conveyor
Used to transport boxes in a straight line for facilities that require a uniform flow of unit loads, maintaining a constant distance or position between them.



Cross transfer roller & toothed belt conveyor
System for a 90° change in direction combining a fixed roller conveyor and a toothed belt lift conveyor positioned at right angles.



Curved roller accumulation conveyor
Useful for defining non-linear flow paths or bypassing architectural or structural obstacles.



Autonomous Mobile Robots (AMRs)

- **Autonomous:** They navigate freely, guided by virtual maps.
- **Intelligent:** They follow the routes generated by navigation software.
- Seamless adaptation to the warehouse layout.
- Tasks executed with **absolute precision**.
- **Safe operation** in highly complex environments involving people, goods, storage systems and other machines.



These vehicles are designed to transport loads between two points independently. They navigate the warehouse freely based on dynamic routes generated by intelligent software which optimises the movements of the AMRs, assigning the perfect route for each task.

Through the use of state-of-the-art sensors and scanners, AMRs are capable of identifying and evading obstacles. They can operate safely in collaborative environments alongside other machines as well as people.



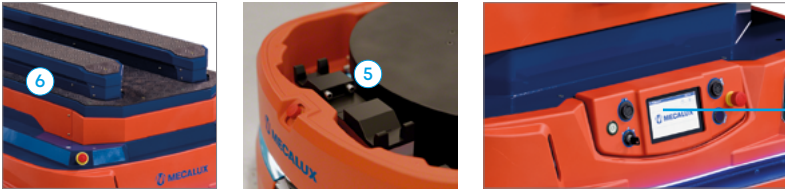

1. Screen
2. Lights
3. LiDAR scanner
4. Emergency stop button
5. Battery
6. Lifting platform

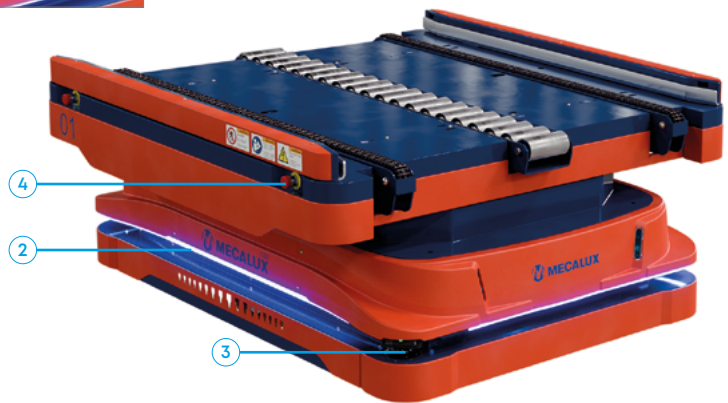

AMR 100 Box

Ideal for transporting boxes, totes, bins, trays and packages. This AMR is equipped with a completely configurable upper conveyor for transferring loads.

Maximum load weight: 100 kg
Movement: autonomous navigation

AMR 100 Multi-Box

Integrates perfectly with collaborative picking scenarios, supplying pick stations and accompanying operators (follow-me mode).

Maximum load weight: 100 kg
Movement: autonomous navigation



AMR 1500 Pallet Conveyor

Designed for safe, controlled in-house pallet movements. This AMR is equipped with an upper conveyor for transferring loads.

Maximum load weight: 1,500 kg
Movement: autonomous navigation

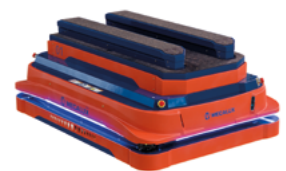

AMR 1500 Pallet Lifter

Transfers pallets using a lifting platform integrated into the robot's upper surface.

Maximum load weight: 1,500 kg
Movements: autonomous navigation and load lifting



Cantilever Racking

- Cantilever racking is ideal for storing **long loads** such as beams, profiles, pipes and timber.
- **Simple, high-strength** structure.



Cantilever racking consists of columns with a vertical beam and one or two horizontal beams at the base to provide stability. A series of arms support the loads.

The height and weight of the products will determine whether the cantilever racking should be light or heavy-duty. Both systems offer the possibility of installing storage levels on one or both sides of the structure.



1. Column
2. Arm
3. Base
4. Cross bracing

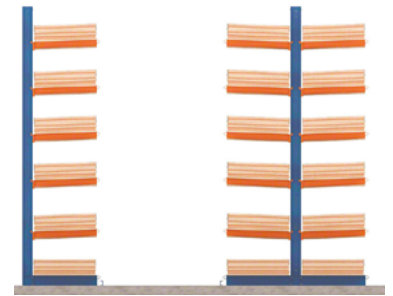
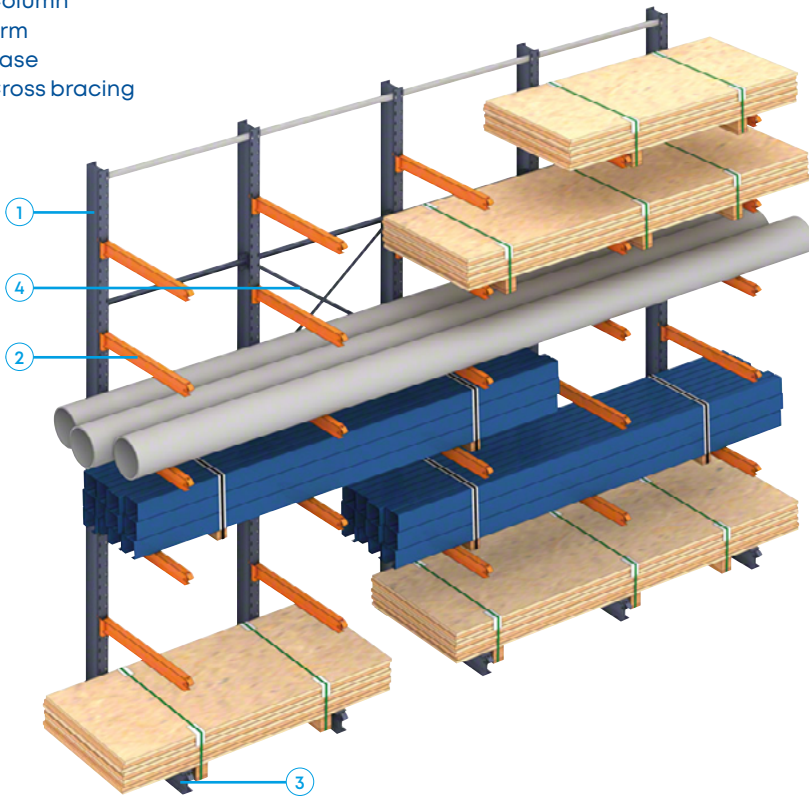

Single- and double-sided versions
 The warehouse is laid out with a combination of single-sided cantilever racking, normally placed against the walls and accessible from one side only, and double-sided cantilever racks, which allow access from both sides.

Cantilever racking on mobile bases

To maximise available space, the cantilever system can be mounted on mobile bases. Using integrated motors, the wheeled structure runs along rails set into the floor. These bases include several control and safety systems to meet client needs.

See more details about this product on page 8.

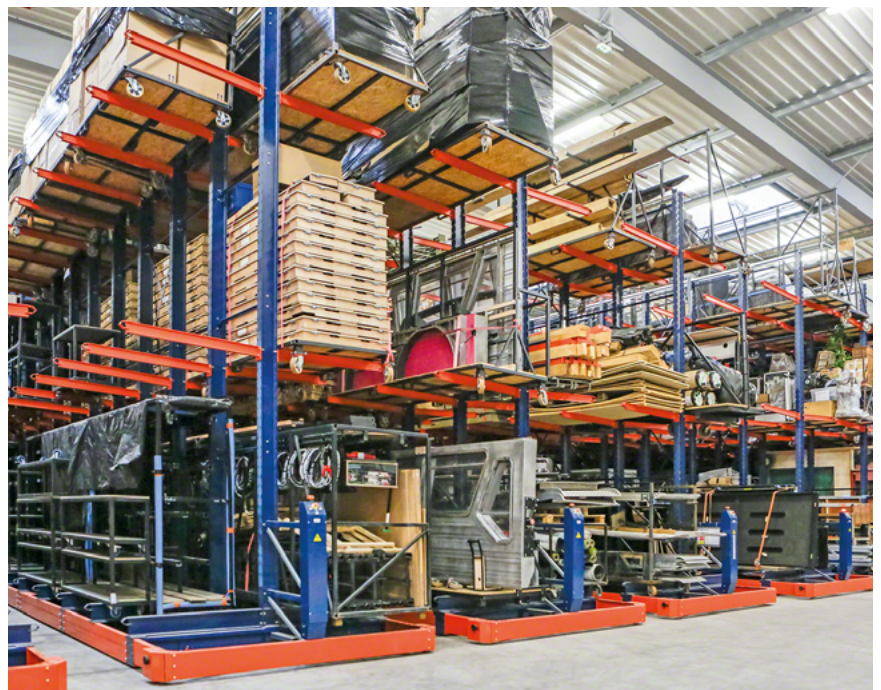
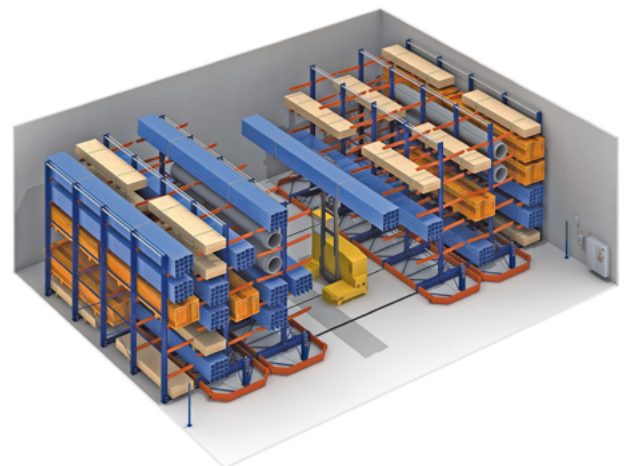

Mezzanine Floors

- Industrial raised flooring to **multiply the original surface area**.
- **Quick and easy assembly**.
- **Adaptable to specific client requirements** thanks to a wide range of accessories, decking types, and building systems.



Mezzanines are the ideal solution for leveraging a facility's surface area, making the most of the building's height.

Mecalux mezzanine floors can be fully dismantled, allowing all elements to be recovered and enabling easy modifications to their structure, dimensions and location.



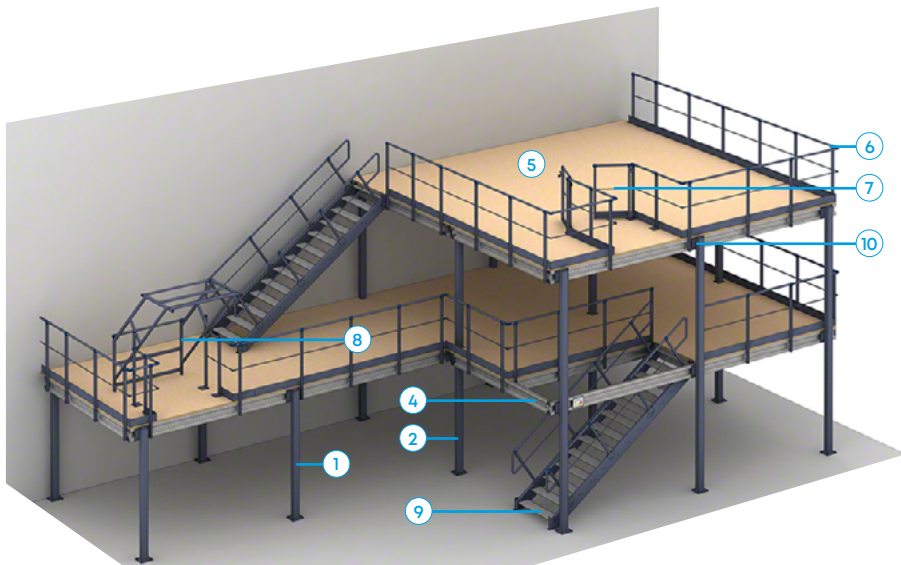

Single column

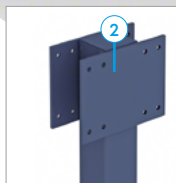

Double column

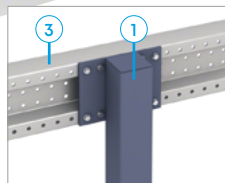

1. Single column
2. Double column
3. Main beam
4. Secondary beam
5. Floor
6. Safety railing
7. Swing gate
8. Up-and-over pallet gate
9. Staircase
10. Fastening plate



Safety railing



Swing gate



Up-and-over pallet gate

Wooden flooring



Chipboard panel flooring



Melamine chipboard flooring
MA/ML



Wooden flooring with sheet
metal

Metal floors

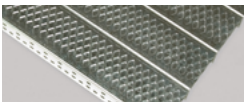

Embossed metal



Slotted metal



Perforated metal

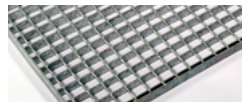

Metal grid



Wire Mesh Partitions & Cages

- **Modular system** adaptable to every area.
- Quick, **easy assembly**.
- Simple to **extend and adjust**.
- Designed according to **European workplace safety standards**.



These create a protected space in workspaces with automated equipment such as AS/RSs and manufacturing robots. They also keep the area clear of materials potentially shed by machine operations.

Elements can be combined in various ways to partition spaces for different purposes, such as separating manufacturing areas with moving machinery, cordoning off chemical storage zones, dividing workspaces within a company or creating enclosures for control and maintenance areas.

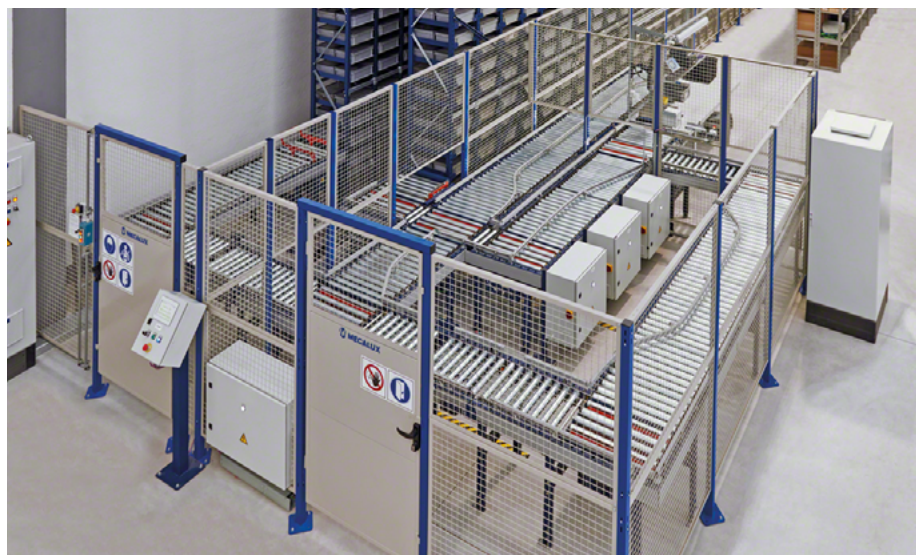

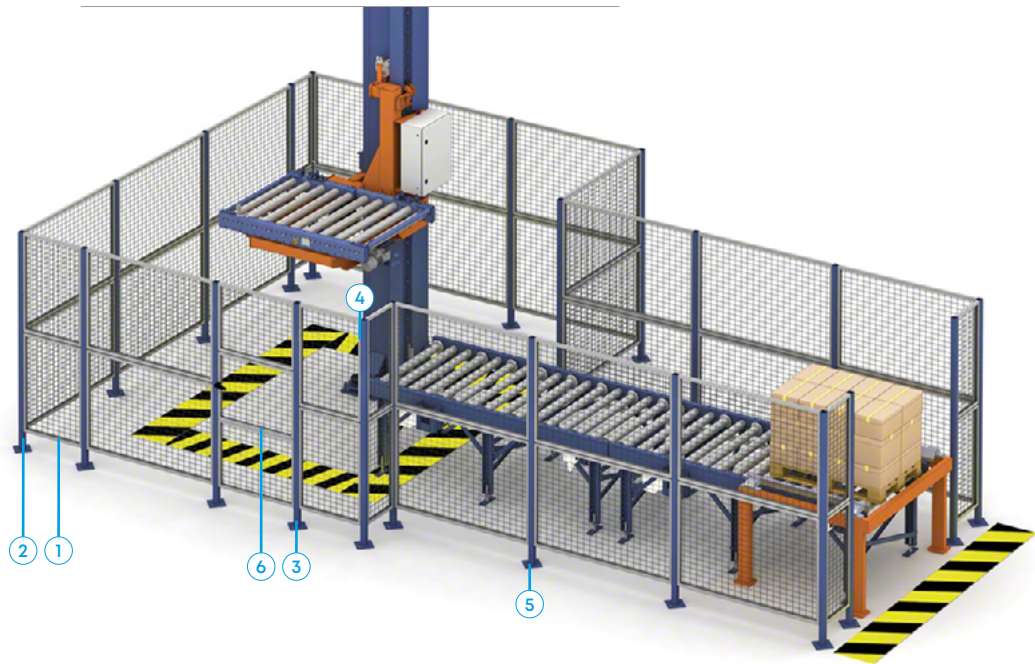

- 1. Metal panel
- 2. Pillar
- 3. Hinged pillar
- 4. Safety switch
- 5. Anchoring
- 6. Access gate

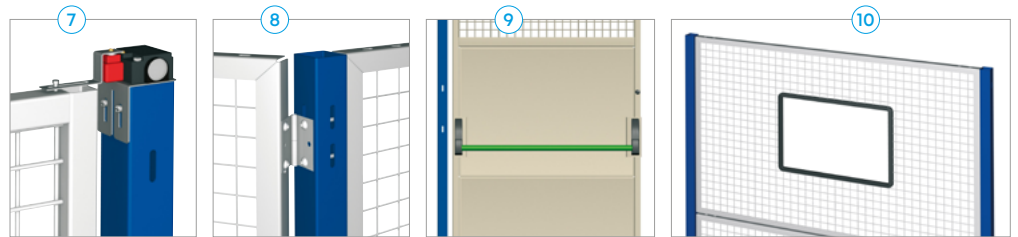

- Accessories**
- 7. Power-off switch
 - 8. Hinged panel
 - 9. Emergency exit
 - 10. Plastic finish



Special Projects

- Consultancy, analysis, development and implementation of **custom projects**.
- **Vast experience** in adapting solutions to a wide variety of specific storage requirements.
- **Rapid**, effective and guaranteed responses.



Mecalux designs, develops and installs tailored storage systems to suit the characteristics or special requirements of any warehouse.

Mecalux provides a solution for all storage needs.





Racking for reels

Racking for reels is designed to provide a simple, safe solution for storing cylindrical items (cable drums, paper rolls, etc.) using a metal axle.

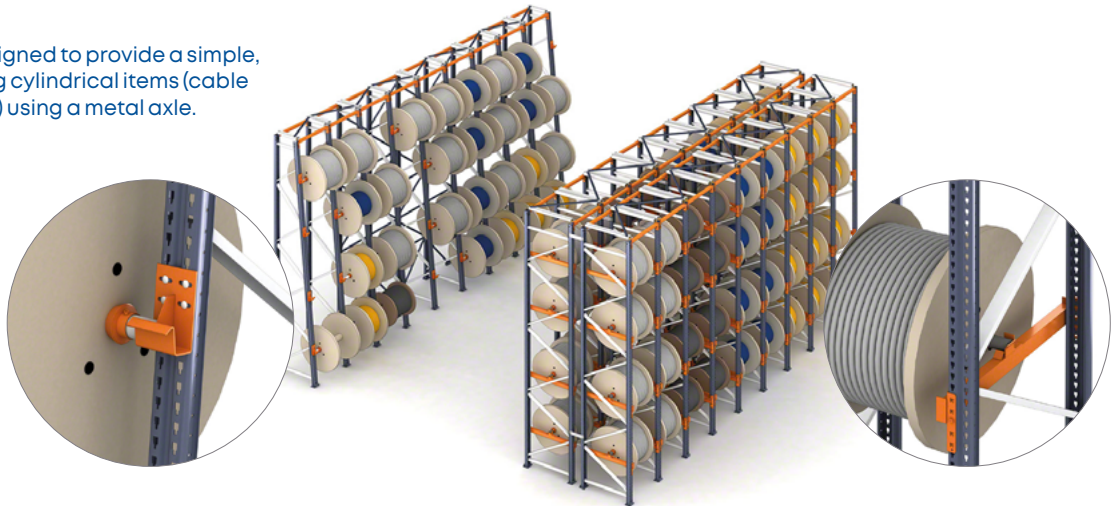

Easy WMS Warehouse Management System

- Receive real-time **inventory** control.
- Lower logistics **costs**.
- Increase storage **capacity**.
- Reduce **handling** tasks.
- Eliminate **errors**.
- Perform precise, high-speed **picking**.
- Adapt to new **e-commerce** needs.
- Manage **omnichannel** operations.
- Achieve a **fast ROI** (in 12-18 months).



The Easy WMS platform optimises the physical and document management of product flows. This guarantees tracking and enhances performance in all warehouse areas: receiving, storage, order picking and dispatch. Its multiple capabilities are suited to any facility, regardless of size or sector.

Easy WMS's extensive range of solutions cover all logistics chain management needs.

Mecalux works with leading suppliers that attest to the quality, reliability and technical level of the Easy WMS platform:

ORACLE | Partner

SAP® Certified
Integration with SAP Applications

Microsoft Partner

ZEBRA
TECHNOLOGIES
SEE MORE. DO MORE.

Interconnected solutions for the supply chain



Multi-Carrier Shipping Software

Automates product packaging, labelling and shipping. Coordinates direct communication between the warehouse and the various transport agencies.



Labor Management System (LMS)

Maximises operational productivity. It objectively measures the operator throughput, identifying opportunities for improvement for the company.



Slotting for WMS

Streamlines location management in the warehouse. It determines the optimal slotting for each SKU based on a set of predetermined rules and criteria (historic, current and future demand).



WMS for 3PL

Manages billing between a 3PL provider and its clients. A dedicated access platform provides information on inventory status and how to place orders or request customised shipments.



WMS for Automation & Robotics

Connects Easy WMS to the main automated storage and retrieval systems (AS/RSs) and robotic intralogistics solutions.



Yard Management System (YMS)

Supervises vehicle movements in the yard of a warehouse or distribution centre. YMS optimises loading dock operations to improve vehicle flow and avoid bottlenecks in inbound and outbound operations.



WMS for Manufacturing

Facilitates traceability in production processes and guarantees the continuous supply of raw materials to production lines.



Store Fulfilment

Synchronises inventory and workflows to ensure optimal inventory management between the central warehouse and the network of brick-and-mortar shops.



Marketplace Integration

Coordinates warehouse inventory with the online catalogue in real time. Easy WMS automatically connects to the main digital sales platforms and marketplaces such as Amazon, eBay and PrestaShop.



Value-Added Services (VAS)

Facilitates product personalisation to drive customer satisfaction. The software sends operators step-by-step instructions on how to customise items and eliminate errors.

Easy WMS in the cloud

- **Lower initial investment** since in-house servers are not needed.
- Faster, simpler **implementation**.
- Easier, more cost-effective **technical support and maintenance**. Total security with Microsoft Azure.
- Software **version up-to-date** at all times.
- **Maximum availability** to ensure business continuity.

Easy DOM Distributed Order Management

- Perfect solution for **omnichannel** challenges.
- Complete visibility of **inventory**.
- Flexible **order orchestration** to meet consumer demands.

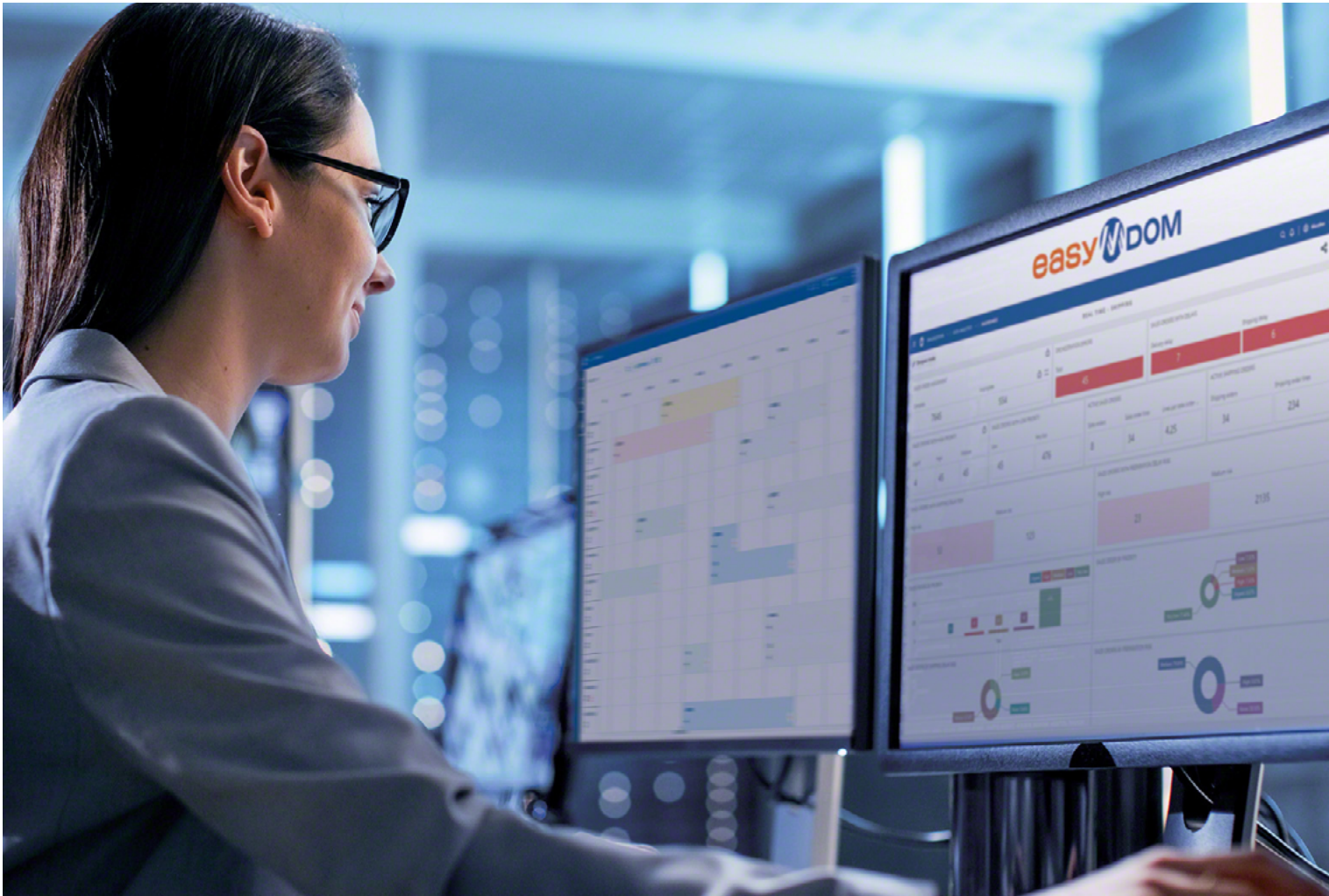

Easy DOM is a cloud-deployed distributed order management system that optimises the selection of order fulfilment locations within a network of warehouses and distribution centres (DCs). Easy DOM operates based on inventory availability and a set of prioritisation rules tailored to a company's business model. To achieve this, the software integrates and synchronises the various supply chain actors. These range from warehouses, shops, 3PL providers and shipping agencies to ERP systems, marketplaces and call centres.

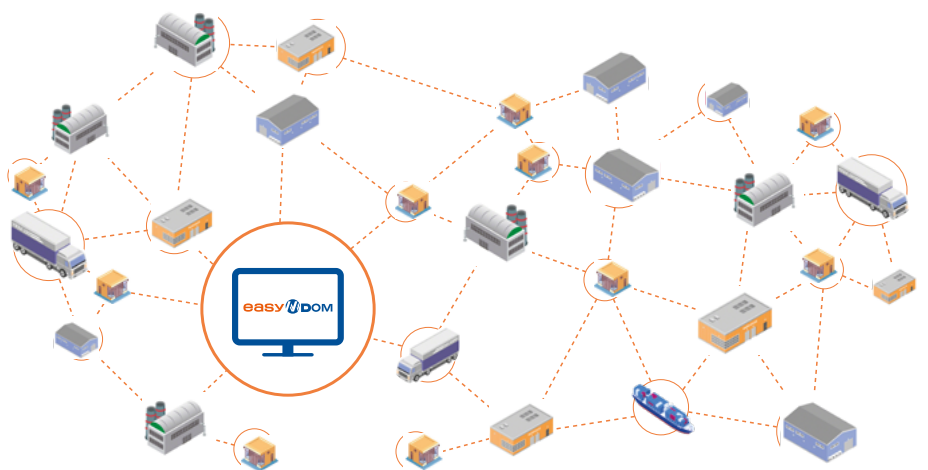

Optimised order routing

Orders are assigned automatically to the ideal shipping locations according to each centre's inventory levels and workload capacity as well as preconfigured prioritisation rules.

Maximum customer satisfaction

Intelligent order orchestration offers shopping experiences that satisfy customer requirements and drive sales. It ensures delivery commitments are met through fast, on-time, error-free shipments.

Global inventory visibility

Aggregated and disaggregated views of the inventory level for each item provide a dynamic, interconnected, real-time view of product availability and flow throughout the supply chain.

Multilevel and omnichannel integration

Consolidating all supply chain levels facilitates the management of complex scenarios in businesses with extended distribution networks that include multiple sales channels and shipping locations.



Core capabilities

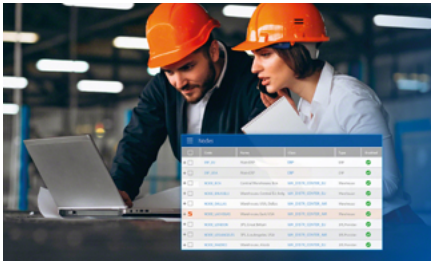

Business rules
Supply chain modelling tailored to business priorities.



Order orchestration
Intelligent management for dynamic, flexible order shipping.

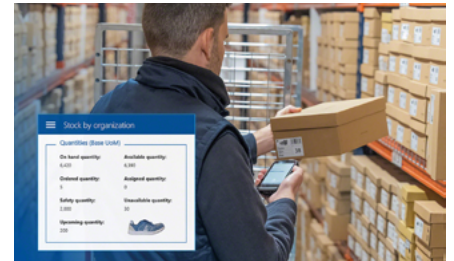

Inventory visibility
Real-time global product visibility.

Additional capabilities



Supply Chain Analytics
Centralised, real-time supply chain monitoring.

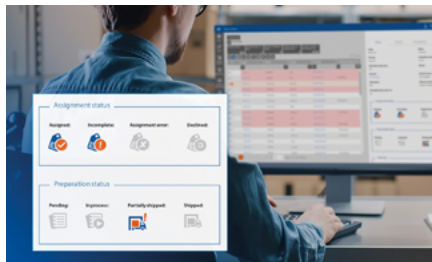

Notifications and alarms
Configurable alerts for immediate incident detection.



Customer service
Detailed monitoring for agile, efficient customer support.

Lifecycle Services

- **End-to-end lifecycle management.**
- **Reactive and preventive maintenance:** incident diagnosis and resolution, periodic maintenance execution and spare parts management.
- **Technical training.**
- **Modernisation** and consultancy for intralogistics facilities.
- **Tailored solutions** designed to meet each company's needs.



Mecalux offers its clients a broad range of after-sales services that cover the lifecycle of all products in its catalogue, from automated storage systems to software solutions.

Mecalux drives productivity and growth for its clients by customising its services, which include reactive and preventive maintenance schemes, technical training programmes and renovation projects. These solutions ensure full warehouse availability and enhance efficiency.

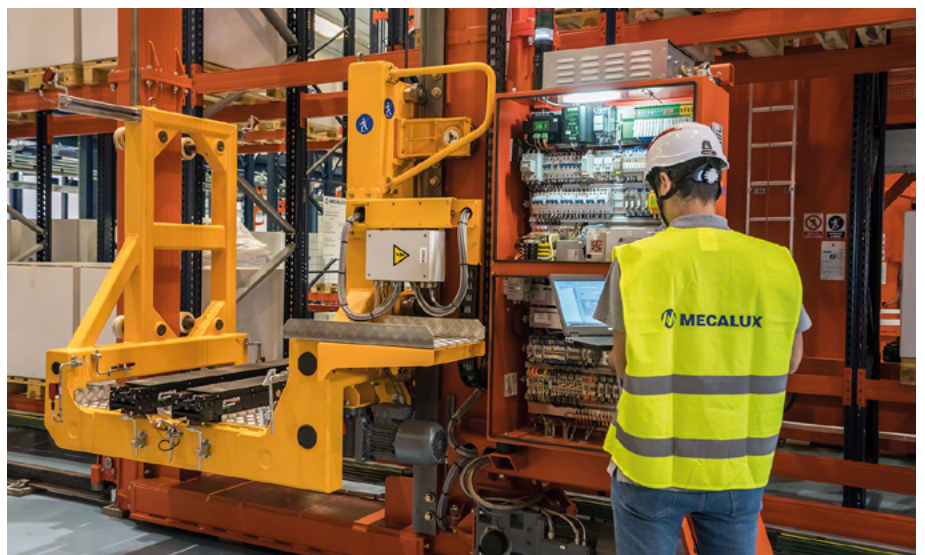

Mecalux covers a facility's entire lifecycle with services that optimise performance and extend durability.



Technical support

Mecalux's lifecycle service catalogue features a wide range of technical support and preventive maintenance solutions that help minimise downtime and optimise operational efficiency. Highly qualified technicians are available around the clock to respond rapidly to incidents.



Spare parts

Personalised spare parts packages created for each client detail the parts and components of each system in the facility. The advanced supply of spare parts ensures immediate availability and speeds up component replacement, minimising warehouse downtime.



Training

Mecalux offers its clients training programmes for company personnel. These courses provide extensive knowledge of operating and maintaining Mecalux solutions.



Warehouse modernisation

Mecalux offers consultancy services for warehouse redesign and modernisation through technology upgrades, process automation and capacity expansion projects.



Warehouse Racking Inspections

- Improved warehouse **safety**.
- **Reduced risks** caused by forklifts or other material handling equipment.



To keep the warehouse safe, it is essential to conduct regular inspections to verify that the racks are in good condition.

The use of forklifts and other handling equipment can cause damage to racking and lead to accidents in the facility.

Standard UNE-EN 15635 requires an annual inspection of storage installations by external, qualified personnel.

Mecalux has offered its customers technical inspection services for more than 30 years to ensure their warehouses are safer and more efficient.



Inspection plan

Our technical specialists perform a thorough technical inspection of the racking systems to confirm the following:

- General condition of **racks**.
- Good condition and suitability of **pallets**.
- Installation **storage levels**, ensuring they match those indicated in the plan.
- Suitability of **forklifts** and **unit loads** for the racking.
- Existence and visibility of **safe load warning notices**.
- **Manoeuvres** are performed correctly by operators.
- **Aisles** are kept clean and in good order.
- Existence of and need for **upright protection**.
- Cracks, subsidence or possible defects in the **floor**.
- Racking **tolerances and deformations**, ensuring they do not exceed set limits.
- Identification of elements in poor condition **using stickers**.
- Notification of **possible risks** in the installation and, potentially, the need to unload bays and levels immediately.



Risk classification

Inspections performed by Mecalux will cover the general condition of the racking, and possible damage will be identified using stickers.



Green level
Only requires monitoring

- No reduction in capacity required.
- Components are safe and serviceable.
- Re-examination and assessment required in future inspections.



Amber level
Action required as soon as possible

- Proceed with replacing the damaged components.



Red level
Immediate action

- Unload the rack immediately, block off access and refrain from further use.

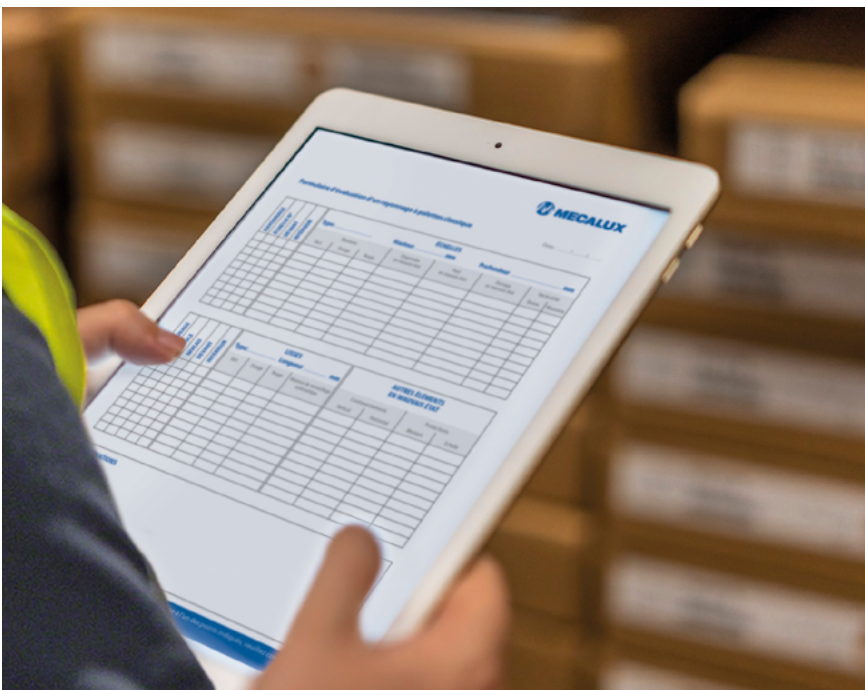

International presence

12 production centres



Plant 1 in Barcelona, Spain



Plant 2 in Barcelona, Spain



Plant 3 in Barcelona, Spain



Plant in Gijón, Spain



Plant in Palencia, Spain



Plant in Gliwice, Poland



Plant in Chicago, US



Plant in Pontiac, US



Plant in Matamoros, Mexico



Plant in Tijuana, Mexico



Plant in São Paulo, Brazil



Plant in Buenos Aires, Argentina

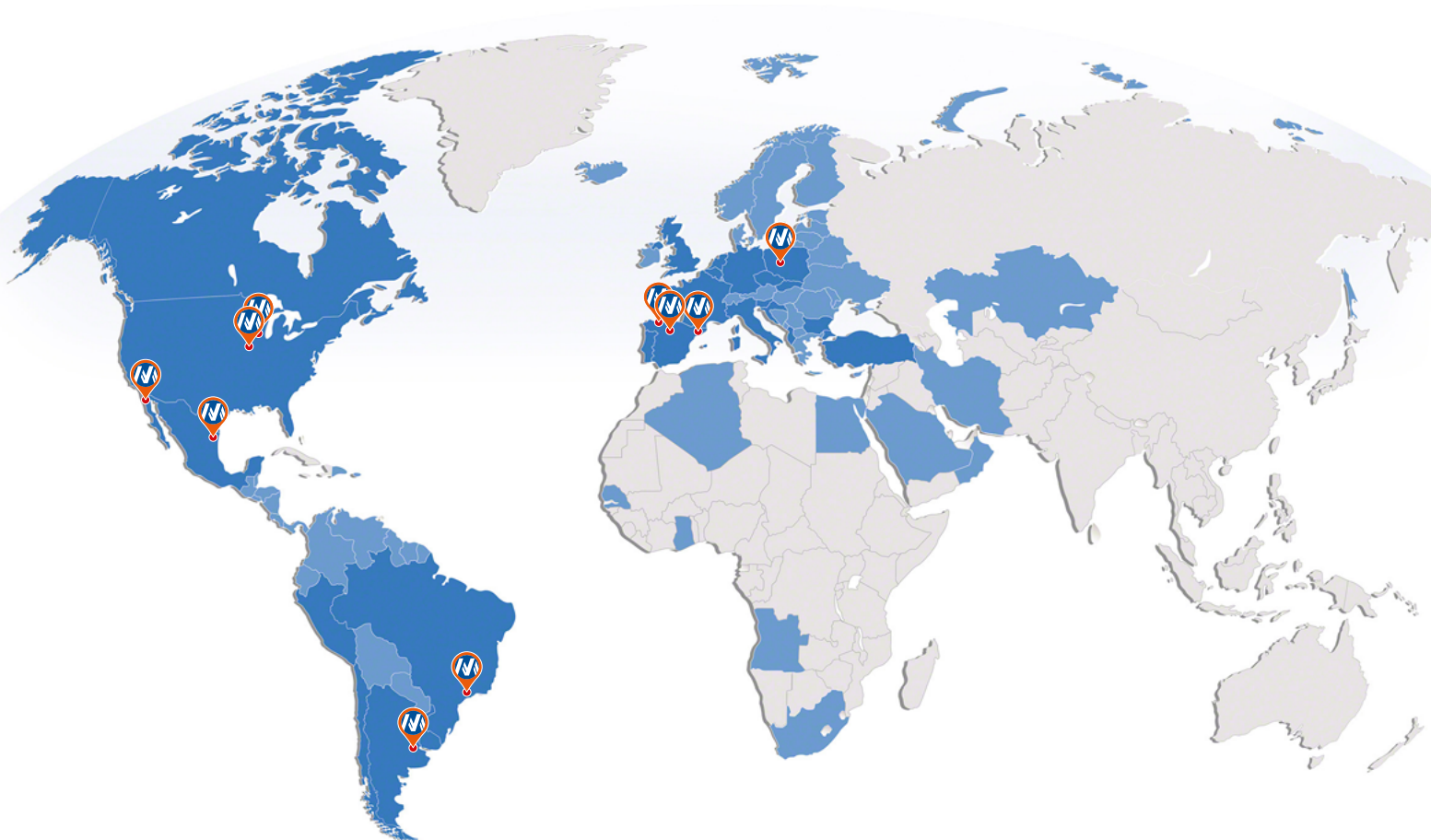

■ Sales network
● Production centres





HEAD OFFICE - SPAIN - Silici, 1 - 08940 Cornellà de Llobregat - Barcelona
Tel. +34 932 616 913 – info@mecalux.com – mecalux.com

EUROPE

BELGIUM

Tel. +32 2 346 90 71
info@mecalux.be
mecalux.be

CROATIA

Tel. +386 41 379 122
pisarna@mecalux.com
mecalux.hr

CZECHIA

Tel. +420 222 524 240
obchod@mecalux.com
mecalux.cz

ESTONIA

info@mecalux.ee
mecalux.ee

FRANCE

Tel. +33 01 60 11 92 92
info@mecalux.fr
mecalux.fr

GERMANY

Tel. +49 (0) 2133 5065 0
info@mecalux.de
mecalux.de

ITALY

Tel. +39 02 98836601
info@mecalux.it
mecalux.it

LATVIA

info@mecalux.lv
mecalux.lv

LITHUANIA

info@mecalux.lt
mecalux.lt

NETHERLANDS

Tel. +31 208 08 30 96
info@mecalux.nl
mecalux.nl

POLAND

Tel. +48 32-331 69 66
info@mecalux.pl
mecalux.pl

PORTUGAL

Tel. +351 21 415 18 90
info@mecalux.pt
mecalux.pt

ROMANIA

Tel. +40 753 098 246
romania@mecalux.com
mecalux.ro

SLOVAKIA

Tel. +421 220 545 117
obchod@mecalux.com
mecalux.sk

SLOVENIA

Tel. +386 41 379 122
pisarna@mecalux.com
mecalux.si

TURKEY

Tel. +90 216 706 10 15
info@mecalux.com.tr
mecalux.com.tr

UNITED KINGDOM

Tel. +44 0121 3336 602
info@mecalux.co.uk
mecalux.co.uk

AMERICA

ARGENTINA

Tel. +54 (11) 4006-4444
info@mecalux.com.ar
mecalux.com.ar

BRAZIL

Tel. +55 19 3809-6800
info@mecalux.com.br
mecalux.com.br

CHILE

Tel. +56 (2) 2827 6000
info@mecalux.cl
mecalux.cl

COLOMBIA

Tel. +57 1 488 1803
info@mecalux.com.co
mecalux.com.co

MEXICO

Tel. +52 800 030 0185
info@mecalux.com.mx
mecalux.com.mx

URUGUAY

Tel. +598 2683-8879
info@mecalux.com.uy
mecalux.com.uy

USA

Tel. 1-877-632-2589
info@interlakemecalux.com
interlakemecalux.com

